



spsfilets

Adventuring together

Construction
Game modules
Accessories



Made in France

EN 2024

Contents

07
18

Construction
of your course



p.19



p.38



p.88

Game
modules

19
137

138
153

Zip-line
games

Complementary
games

154
158

159
175

Accessories

Anchoring solution
Kujanak

176
182

Our know-how

Made  by SPSfiles

In our workshop we provide you with our know-how, associated with great rigour, allowing us to master every stage of the manufacturing process.



Proud member of



Crimping workshop

Made  by SPSfilets

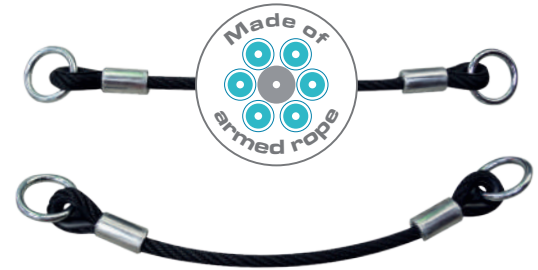

The crimping technology gives an unequalled finish and a better life-time.

It also offers high-end elements with more color choices within your aerial rope courses.

Please feel free to contact us !

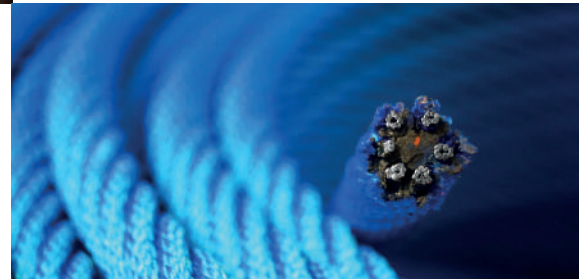

Type of wood

We supply a “ready for use” range of woods which comes from French forests and gives you the choice of wood’s variety for your constructions.



- 1 - Sustainable chestnut wood** (+20 years). EN 350-2 Class 4 Standard according to NF EN 335-2. Chestnut wood is an environmental-friendly alternative against chemically treated wood. It does not need particular treatment/facility at the end of its life.
- 2 - Sustainable larch wood** (+20 years). EN 350-2 Class 3 Standard according to NF EN 335-2. Larch wood is a natural wood which does not need preservation treatment.
- 3 - Autoclave Class 4 wood chemically treated** EN 351-1 Class 4 Standard.

Make up your tailor-made obstacles easily

Thanks to our range of possibilities, bring some personality, colors and fun to your courses.

Wood engraving technic
on CTBX exterior plywood
via digital control.



Digital print
on CTBX exterior plywood.



Wood painting.

Wood cutting
plywood on
digital machine.



Please feel free to contact us !

Discover also our alternative materials

New materials for new play modules, let's create together your future circuits with these innovative materials.

HPL

Compact laminate for even more durable modules!

8 mm or 12 mm.

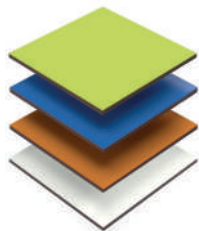

Wide choice of colours
Ask us more information!

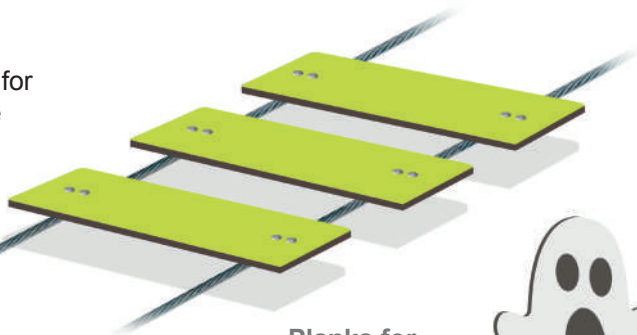

Planks for
bridge, foot
plank islands...



Planks
for bridge

PEHD

recycled plastic UV
and weather resistant.

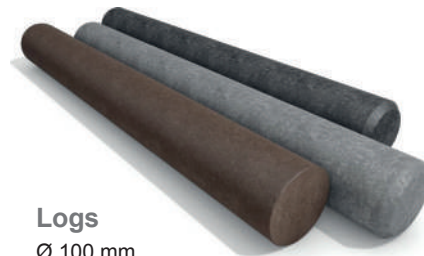

Logs

Ø 100 mm
or Ø 120 mm.

Please contact us
for delivery times !

Platform on bracket



Standard

Treated timber class 4.
Board thickness 32 mm
(1,25 in)

Preserved
trees



Option

Platform for zip-line easily
adaptable to the standard
model.

Preformed foam
protection page 162

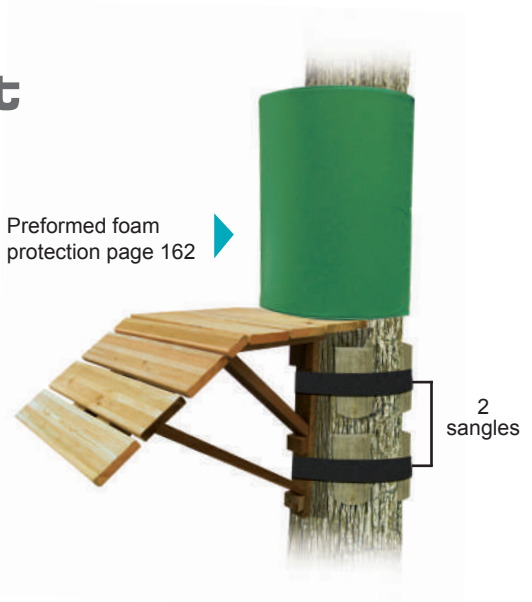

We can deliver also

- Straps width 35/50 mm.
- 1/2 logs.
- Screws.



Pimp my platform



Coloured non-slip exterior plywood.
Floor thickness 15 mm.
Attached to an autoclave wooden bracket.

Floor shape:
apple, pear, cloud or
circular plank Ø 800 mm.



Floor colours:
black, yellow,
blue, green or
red.

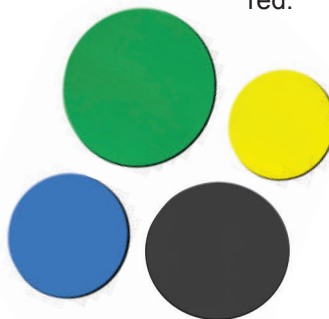

Kit platform



Inclined half-pipe

Coated dark green steel cuff
Ø 120 mm, to build an inclined
plane for safety.

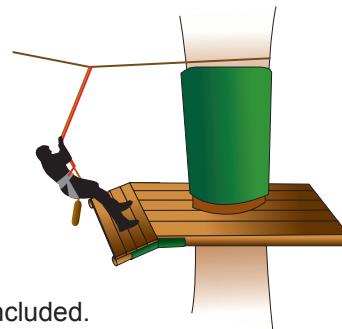

Standard dimensions: 1 m ■ 1,50 m ■ 1,80 m ■ 2 m.

Treated Timber class 4. Composed of:

- Pre-drilled logs Ø 120 mm.
- Half landing deck with grooved boards (rectangular or circular).
- Assembly accessories (threaded rods, nuts, washers, screws...) are included.

Wooden accessories

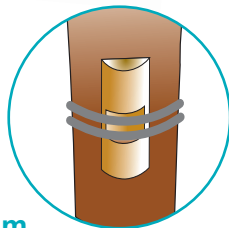
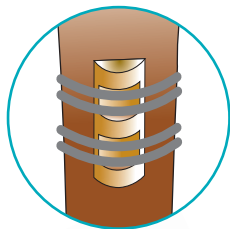

Wooden wedge Ø 100 mm

Treated Timber class 4.
With one or two notches to protect trees.

Also exists in Ø 125 mm for Sea of nets, Courses without harness, Funbox and installation of long zip lines.

Wooden wire rope spreader

Treated Timber class 4.

Available in two lengths:

- 750 mm: spacing 658 mm.
- 1100 mm: spacing 1008 mm.



Supplied with
screws and
bolts



Sleeved sling

Galvanized wire cable Ø 12 mm 7 x 19 mm equipped with 1 thimble and large opening at one end + plastic sheath at the other.

Length

2,50 ■ 3,50
4,50 m.

Allows
to hold
the fixing plates
of the lifeline

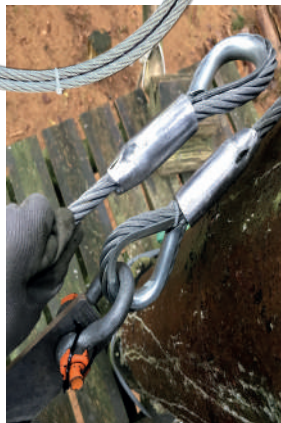

Vertical access for platform

Galvanized steel cable Ø 12 mm, 7 x 19. Custom-made. Thanks to its “cob” system, it allows to stop the user in case of fall before he touches the ground. Standard NF CE 15567-1.

- Replaces a stop-fall.
- Doesn't require maintenance.
- Improves the fluidity at the start of the course.

Allows to secure the access of your elevated platforms.



Equidistance barb:

children: 40 cm ■ adult: 50 cm.



Adjustable spacer bar

1

Adjustable spacer bar

For bridges.
Adjustable from
1,25 m to 2 m.
Painted steel,
grey colour.

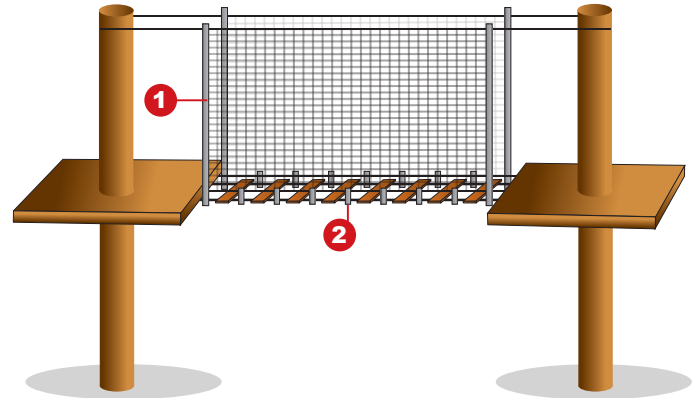

2

Junction plate

For cable at the bottom.
Painted steel, grey colour.



Metal accessories



U spreader
For net and rope bridges.
Length:
0,50 et 1 m.



Straight bar
For the construction
of a plank bridge.
Length:
1 m.



Spreader
For monkey
bridges.



V spreader
For wire
rope monkey
bridges.



Open steel circle
Ø 800 mm ■ Grey colour.
For the open barrel.



Steel circle
Ø 800 mm ■ Color: grey.
For the construction
of barrels.

Wire cables and hardware

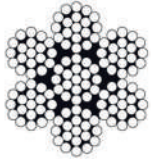

Galvanized steel wire rope (steel core)

Ø	Quality	Breaking strength	Construction
10	1960 N/mm ²	7233 kg	7 x 19
12	1960 N/mm ²	10400 kg	7 x 19

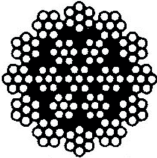

Non rotating steel cable (steel core)

Ø	Quality	Breaking strength	Construction
12	1960 N/mm ²	9437 kg	19 x 7



**Wire rope
tighteners CE**
Ø 8 | 10 | 12 mm.



High resistance shackle
Ø 10 mm to 32 mm.



Straight shackle
CE Ø 16 mm



We also supply



Wire rope tightening bolts
Ø 12 mm.

Nylon cap nuts

Ø 8 mm for wire rope tightener
Ø 10 mm for wire rope tightener
Ø 12 mm.

Packaging:
100 or 1000 pieces.



Bulldog
wire rope tightener.

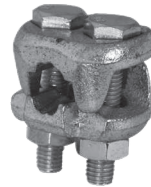

Steel sleeve
Ø 13 mm.



Zinc cap nuts

M8 ■ M10 ■ M12.



Thimble
Ø 10 to 20 mm.

Quick links

Simple to large opening
Ø 8 to 14. CE



DELTA link
Ø 8 to 14 mm. CE

The game modules are supplied with accessories and packed in small packets.



Lifting and handling material

Pliable unwinder

Pliable unwinder for cable drum.
100 lm or 500 lm.

Doesn't take up a lot of space: pliable.

- Length: 530 mm.
- Width: 561 mm.
- Weight: 12 kg.

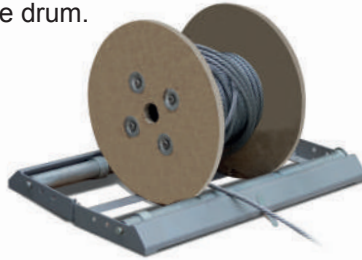

Tubular sling

Length: 1 m
1,5 m - 2 m - 2,5 m.
Resistance: 2 T.
Possibility of colour
brown and black
on request.

Wire-strainer

Light, easy to handle
and small size. Capacity
600 kg for 7 mm to
15 mm cable.



Block and tackle

It has been designed
for hoisting, traction and
stowage works in any
technical elds. 250 kg -
500 kg - 1500 kg.

Wire rope-gripper

Full wire rope-gripper
with shackle. Capacity
380 kg for 7 to 15 mm
cable or wire rope.



CONI - KLAM

Wire rope gripper
in conical shape
Load: 2T from 10,50 mm
to 14 mm cable.



Portable system

to shrink caps and heat-shrinkable sheaths.



2
Butane/Propane mix gas cartridges



With 2 gas cartridges you can retract 200 heat-shrink caps.



1
Gas Torch

Heat-shrink end caps

Perfect to protect cable ends.

For cable Ø 5 to 12 mm. Color: black. Length: 7 cm, 4,50 cm (bag of 100 pieces).

Rope reel



The rope

In reels. Color: green, beige, havana, white, black.

Electric iron hot cut



Available for sale

Suspension ropes

We provide the suspension ropes you need to build your obstacles.

- Thimble eye and suspension ring at one end and hot-cutting at the other end.
- Thimble eye and suspension ring at each end.
- Thimble eye and suspension ring crimped on armed rope at one end and threaded rod with washer and nut at the other end.

Our suspensions

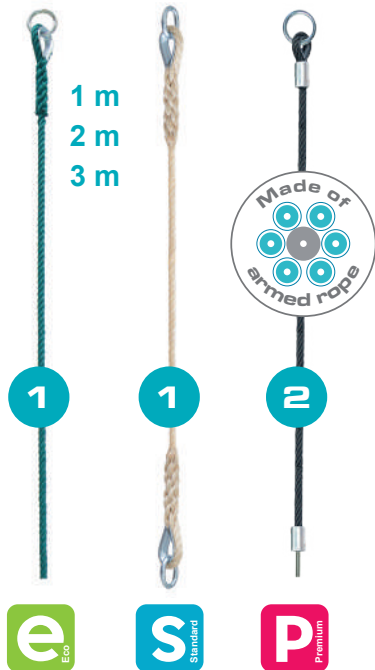

1 - Colors black, green, beige, havanna, yellow or blue (in Polypropylene)

2 - Colors black, green, beige, yellow or blue.



Can be sold per bundle upon request

Our products



Stairs

Easy and quick assembly

Build your own stairs to get to the platforms.
Treated timber class 4. Length 60 cm. Plank
Thickness: 27 mm.



Trees are preserved

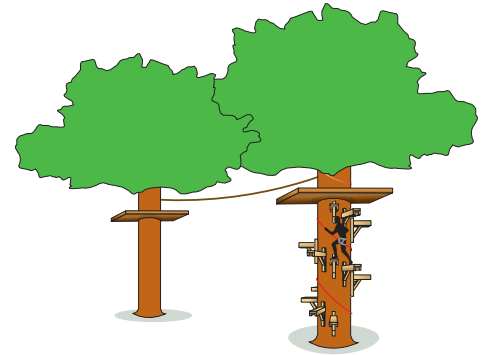
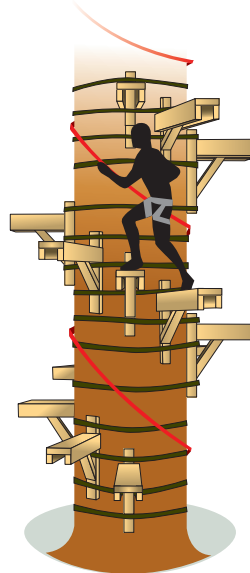

Ratchet strap
to attach
the stairs.



Level of difficulty



Flying Net

Polypropylene Net, Ø 16 mm, 250 mm square mesh with a ring on each corner.

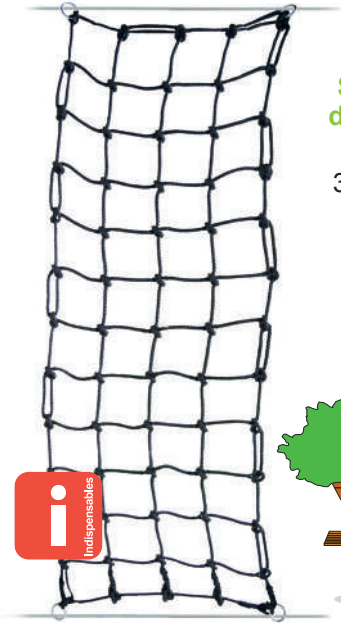

Standard dimension in stock

3 m* x 1 m.

Color black.

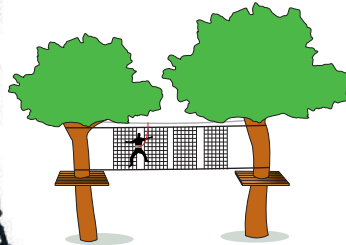

Level of difficulty

Climbing net knotted

Polypropylene knotted net Ø 16 mm meshes 250 mm square, with ring at each end.

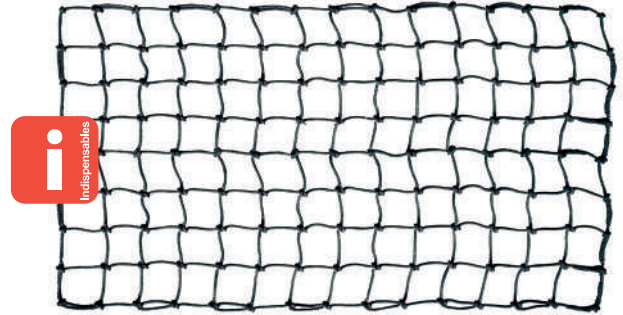

Climbing net - Color black only

Ø 16 mm, 250 mm mesh..

Several dimensions available in stock

2 x 2* - 2 x 3* - 2 x 5* - 3 x 3*

6 x 3* - 4 x 4* - 5 x 5*.

* height of the net



Level of difficulty



Finnish skittle

10 cm Ø log, wood autoclave class 4, beveled at one end. Stenciled on the beveled part. Length 40 cm. Delivered with accessories. Sold in packs of 12 skittles



Cable spacing
30 cm.

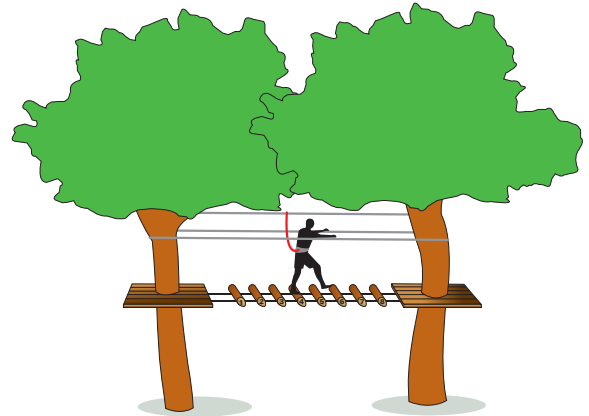

Mikado

Class 4 autoclave wooden post, with blue and red paint on the ends, to be installed vertically as an obstacle on a footbridge.

Dimensions:

250 cm x Ø 70 cm.

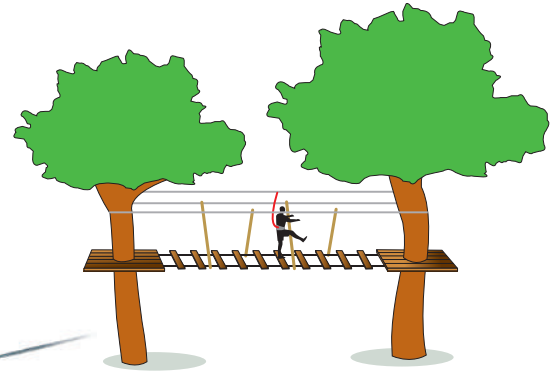
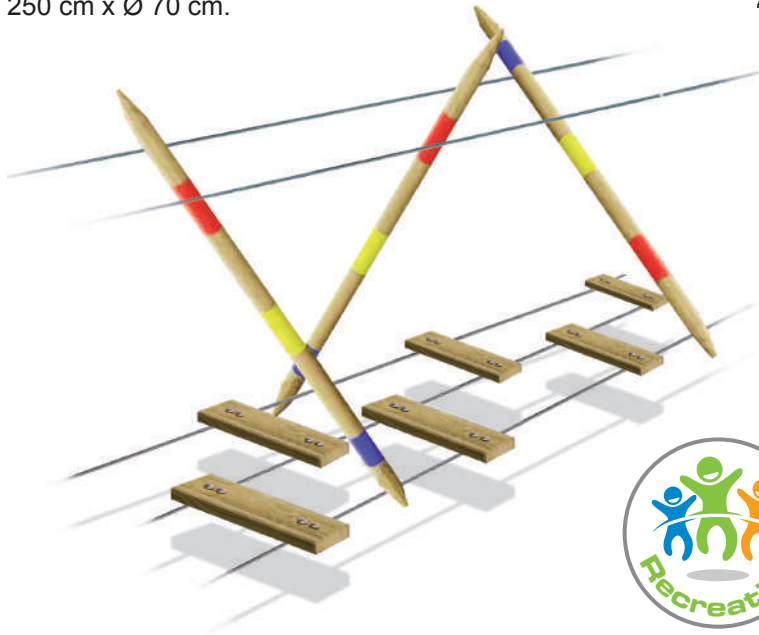

Level of difficulty

Mini-foot

Non-slip CTBX exterior plywood engraved and stained –thickness 15 mm. To be installed on 2 parallel cables and supplied with assembly accessories.

Dimensions: 55 x 25 cm.

Wire cable spacing: 13 cm.



Level of difficulty

Tic Tac Toe

X or O in anti-slip CTBX birch plywood, engraved and stained. Thickness 15 mm. Installed on 2 wire cables. Supplied with assembly accessories.

Wire cable spacing: 30 cm.

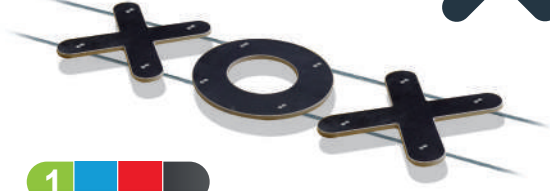

Level of difficulty

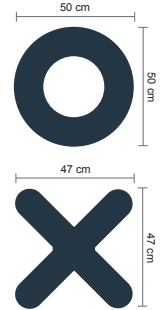

Domino's footbridge

Planks in form of Domino's, in CTBX birch plywood, non-slip, engraved and stained. Installed on 2 wire cables. Supplied with assembly accessories. Set of six dominos.

Dimensions: 70 cm x 39 cm.

Wire cable spacing: 30 cm.



Level of difficulty

The Moon

Three quarter steel tube to install vertically in staggered rows. Installed on 2 wire cables.



Level of difficulty

Wooden staircase

Wood platforme made of autoclave class 4 wood, composed of 2 Ø 100 mm logs and 3 graved planks. Dimensions: 0,50 m x 0,70 m.

Wire cable spacing: 50 cm.

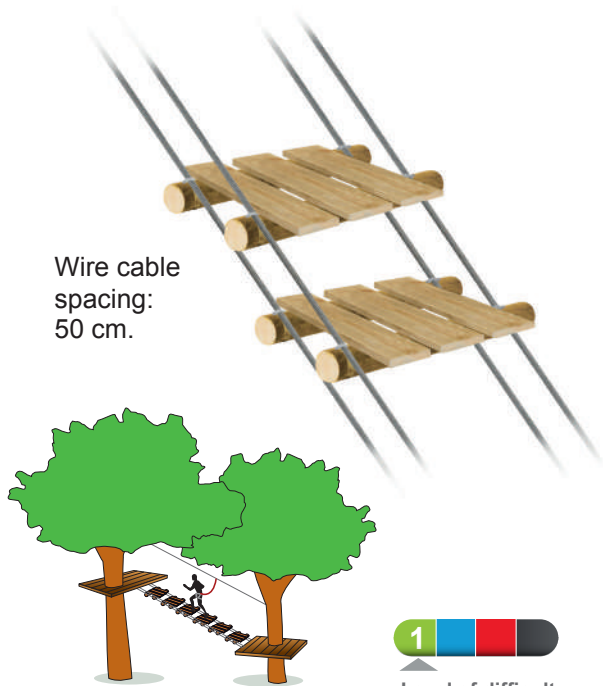

Flying square

Made of wooden square rafter 90 x 90 mm, autoclave class 4. Dimensions: 0,60 x 0,60 m. With quick link M6 Large Opening.

Suspension sold separately and to be mounted by yourself.

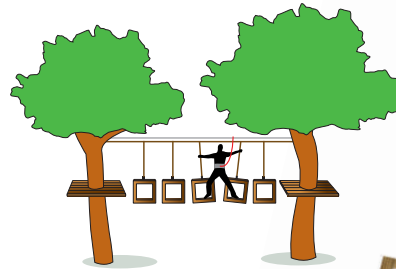

Threaded frame

Made of autoclave class 4 board, equipped with knotless 45 mm black polypropylen net. Dimensions: 0,60 m x 1,50 m.

Accessories included.



Level of difficulty

Walking square

Made of 90 x 90 mm wooden square rafter. To be blocked with cable clamps (not supplied). Length : 0,60 m.

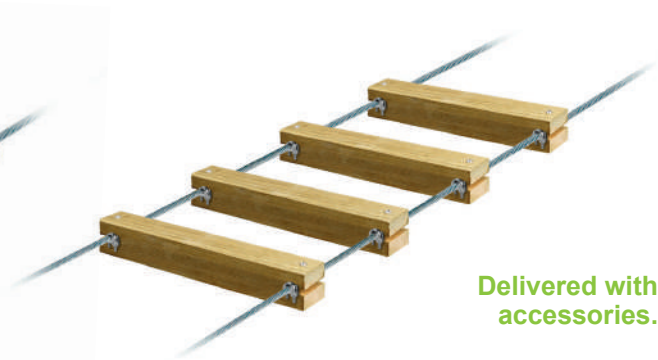

Delivered with accessories.



Level of difficulty

Elastic plank

Made of grooved board, thickness 36 mm, autoclave class 4. With self-assembly accessories. Width: 165 mm. Length: 1m.



Moving planks

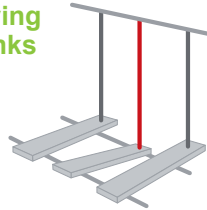
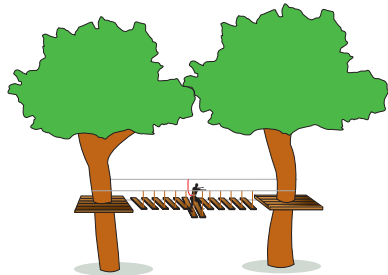

Surf climbing

Made of grooved board, autoclave class 4. Dimensions: 1,50 m x 165 mm. Thickness: 36 mm.



Delivered with accessories.

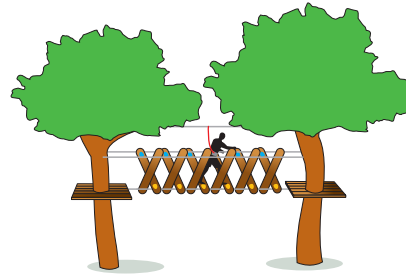

Zigzag rope

Made of \varnothing 20 mm rope made of dark green polyethylene, equipped with thimble eye and suspension ring at each end and locked with 3 knots with ring. Length: 3 m.

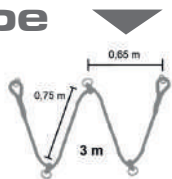

Level of difficulty

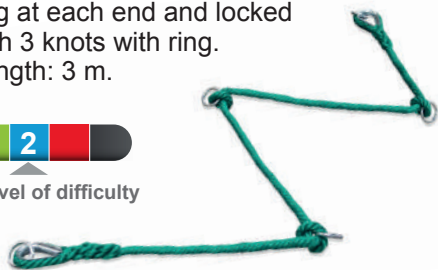

Crossing rope

Made of dark green rope \varnothing 20 mm in polyethylene, equipped with thimble eye and suspension ring at each end, to be attached on a cable. Length: 1 m.

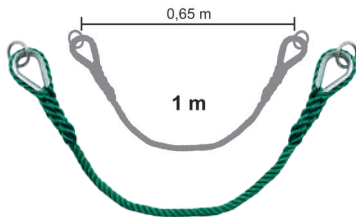

Level of difficulty

Color green.

Crossing rope

Made of dark green rope \varnothing 20 mm in polyethylene, equipped with thimble eye and suspension ring at each end, to be attached on a cable. Length: 1 m.

Spacing: 0,56 m.



Level of difficulty

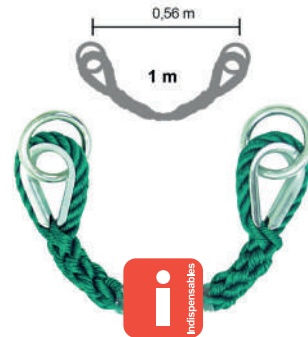

Hand rope

Made of \varnothing 20 mm dark green polyethylene rope, fitted with thimble eye and suspension ring at the top, a knot and a heatshrinkable cap at the bottom.

Length: 0,80 m.



Level of difficulty

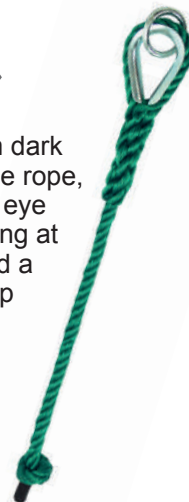

Hammer

Made of wooden square rafter 90 x 90mm, class 4 autoclave. Installed on 2 wire cables. Height 1,80 m. Equipped with a counterweight.

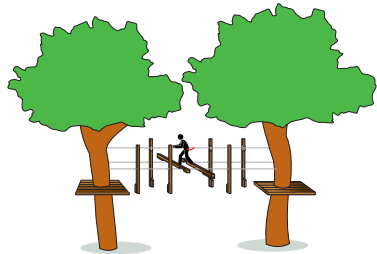

Level of difficulty

Banana planks for bridge

Non-slip wood, banana form - length 500mm. Thickness: 15 mm.



With assembly accessories.

Playful and fun for kids

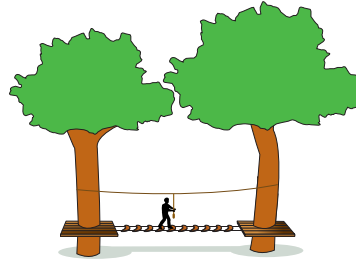

Level of difficulty

Planks for bridge

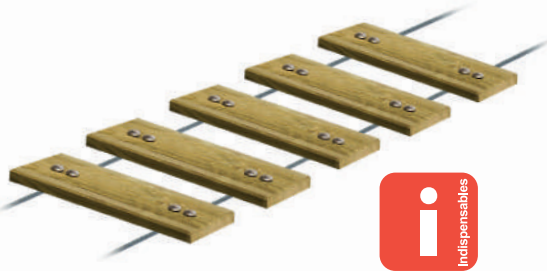

Grooved wooden planks for bridge

Width:
145 mm.

Thickness:
27 mm.

Length:
500 mm.

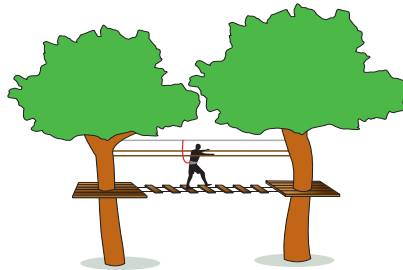

Level of difficulty

Including assembly accessories
(wire ropes spacing: 400 mm).

Tightrope walker planks



Grooved wooden planks for bridge

Width:
145 mm.

Thickness:
27 mm.

Length:
1 m et 2 m.

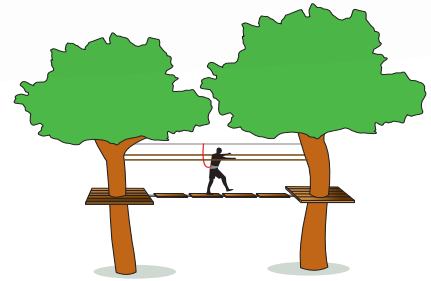

Level of difficulty

Including assembly accessories
(wire ropes spacing: 100 mm).

X to walk

Made of 2 autoclave class 4 pine, assembled together in a cross shape. Supplied with assembly accessories.

Dimensions: 96 x 62 cm.

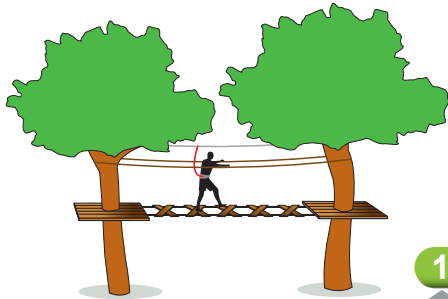
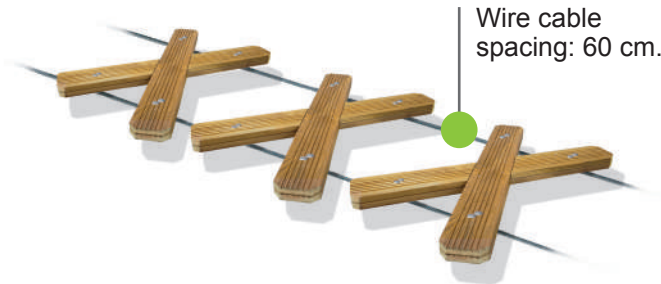

Snake

Including 2 grooved wooden plank treated class 4, one measuring 1,145 m and the other measuring 2 m.

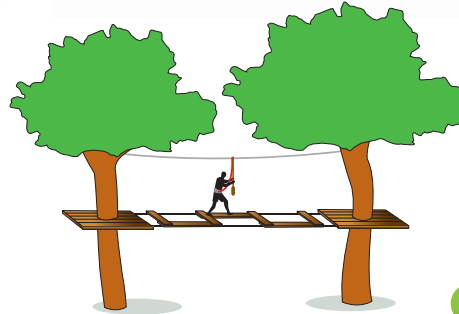

Dominoes

Wood planks treated autoclave class 4, assembled on bearing. Automatic motion.

Length:
1 m.
Width:
9 cm.

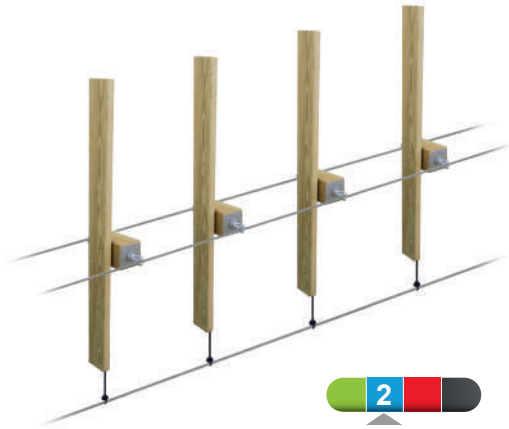
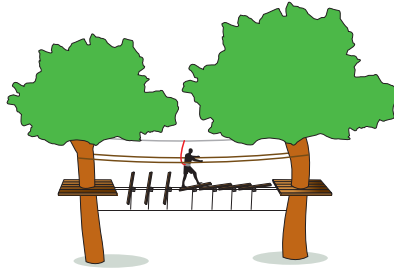

Level of difficulty

Stilt

Beech wood log Ø 100 mm, treated autoclave class 4. Length 0,66 m. Small walking log Ø 35 mm.

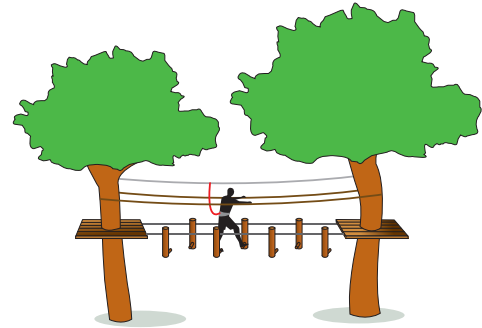

Assembly accessories are included.



Level of difficulty

Dancing bridge

Set of 3 posts 90 x 90 mm, held together by a \varnothing 16 mm threaded rod covered by a black \varnothing 28 mm aluminium tubing.

Module is equipped at each end with 6 green polypropylene suspension ropes \varnothing 16 mm, length 3 m.

Dimensions:

70 cm x 8,5 cm x 8,5 cm.

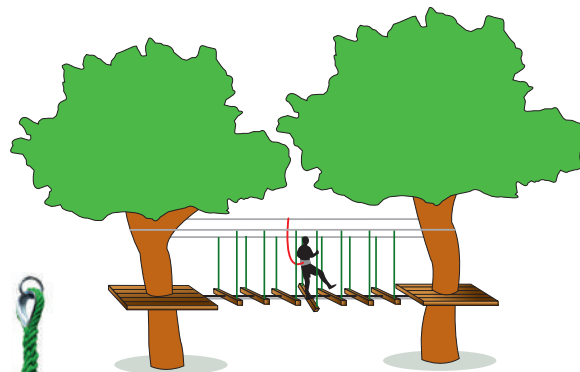

Level of difficulty



U-form rope

Made of dark green rope Ø 20 mm made of polyethylene, equipped with thimble eye and suspension ring on each side of the end.

Standard lengths:

2 m et 4 m.

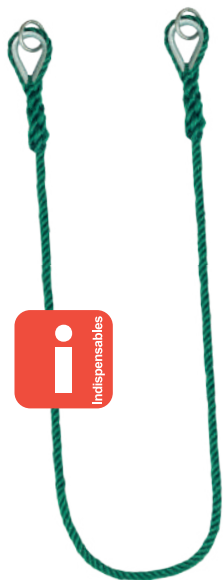

Color green.

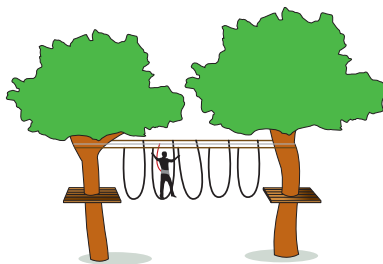
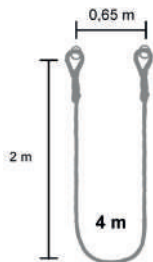

Level of difficulty

Flying door

Made of 90 x 90 mm wooden autoclave class 4 square rafter. Width: 0,80 m. Height: 1,50 m.



Suspension sold separately and to be mounted by yourself.

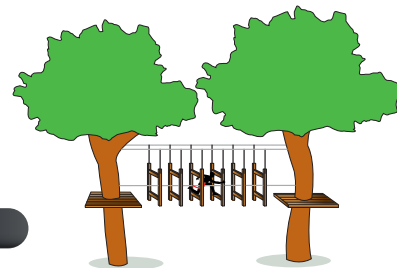

Level of difficulty

Accordion log

Made of Ø 60 mm log, autoclave class 4, with 2 holes for the passage of ropes. Length: 0,50 m.



Level of difficulty

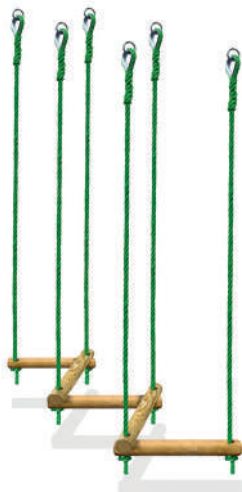

Accordion board

Made of grooved board, autoclave class 4, width 145 mm. Equipped with 2 holes for the passage of ropes. Length: 1,10 m.



Level of difficulty



Hanging frame

Made of grooved board, autoclave class 4, with 4 holes for the passage of the ropes. Dimensions: 0,50 x 0,50 m.



Level of difficulty



Hanging bridge

Made of grooved board, autoclave class 4, with 4 holes for the passage of the ropes. Dimensions: 0,50 x 0,50 m.



Level of difficulty

Suspension sold separately and to be mounted by yourself.

The pawn

Hanging foam obstacle equipped with a suspension ring.

Standard color: green.

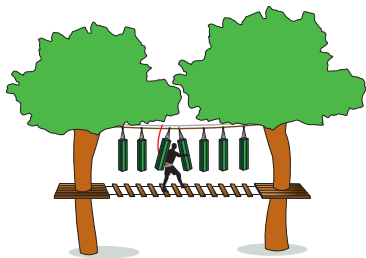

Foams length: 0,90 m.

Total height: 1,50 m.

Other colors on request.



Level of difficulty

Liana

Foam obstacle Ø 10 cm. Each end is closed and equipped with a fixing ring.

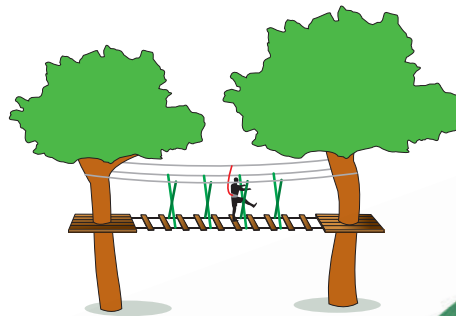

Color green.

Length: 2 m.

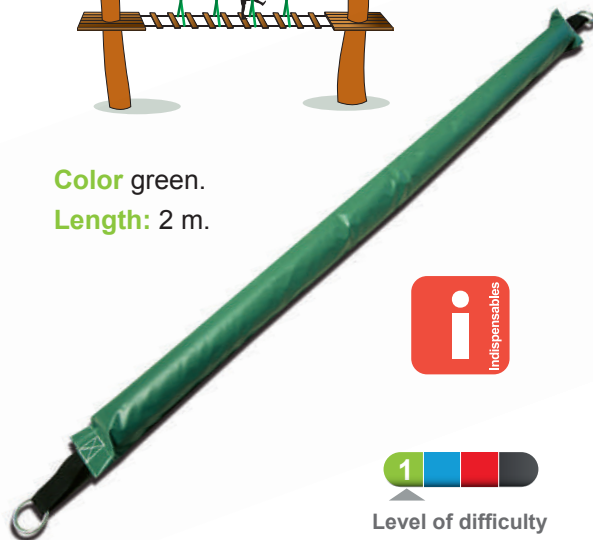

Level of difficulty

Slackline

Cruise Kit

- Intended as an introduction for all the family.
- Can be installed as you wish.

Width 50 mm. This strap gives you increased safety because it can be installed at knee height, making it safe for beginners.

Length 15 m.



Other Slackline kits are available. To find out more, please don't hesitate to contact us.

The slide

Polyester Tarpaulin

PVC coated.

900 g/m² with a slit on either side for insertion of the wire rope.

Hemmed with eyelets at top for attachment to platform.

Color: green.

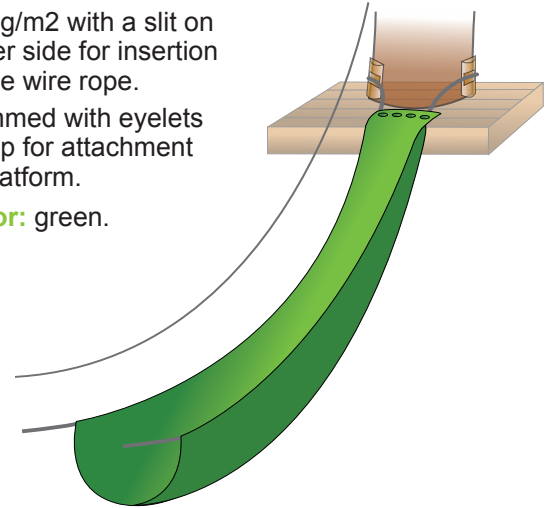

Possibility to add eyelift on the length to secure thanks to a safety net.

Width: 1 m.



Walking net

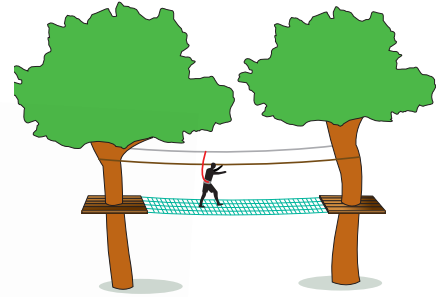
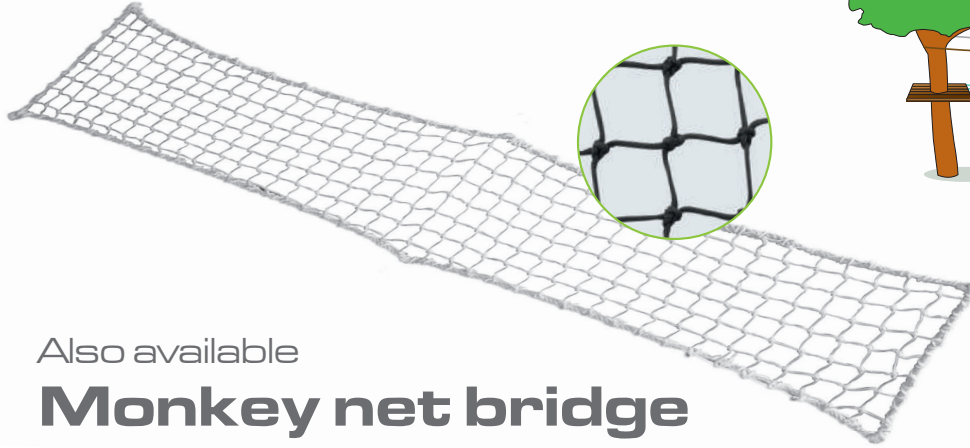

Also available

Monkey net bridge

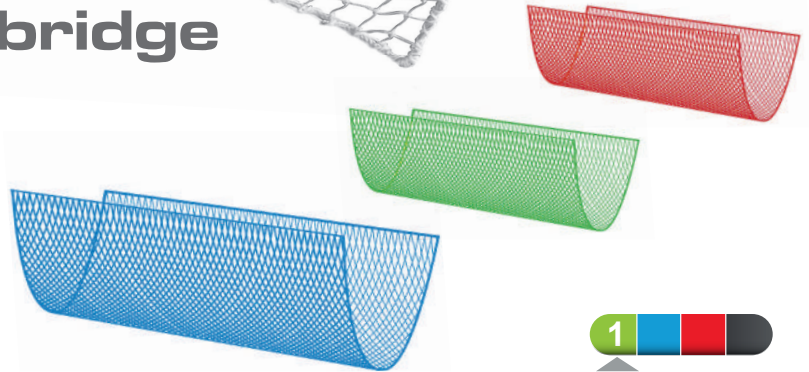
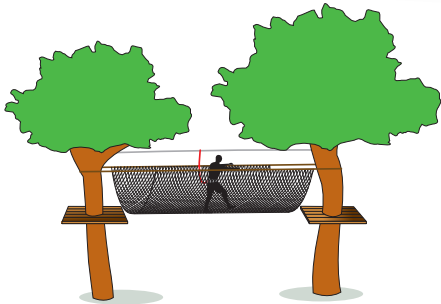

Level of difficulty

Braid: polyamide Ø 4,75 mm.
Mesh: square, 50 mm knotted.
Boltrope: Ø12 mm sewn all around the net. Color: white or black.

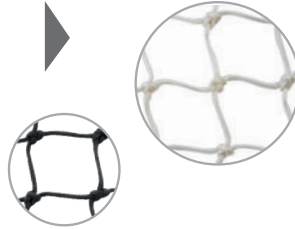

Braid: polyamide Ø 5 mm.
Mesh: square, 30 mm knotless.
Boltrope: Ø 10 mm color white sewn all around the net.
Color: beige.

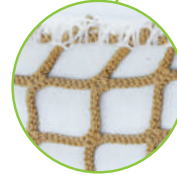

Option strop with thimble

Multi-purpose and easy assembly.
Standard length 30 cm.
Color white, black.

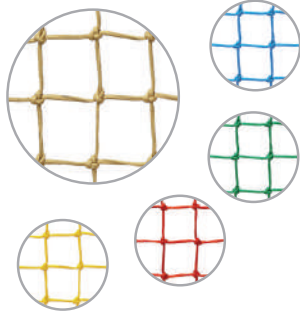

Braid: Polyester 4,50 mm.
Mesh: 50 mm knotted square mesh, with perimeter bolt rope Ø12 mm, black.
Beige, blue, yellow, red or green mass-coloured net.

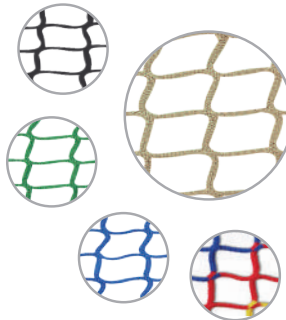

Braid: Polypropylene 5 mm.
Mesh: 45 mm knotless mesh.
White perimeter bolt rope Ø 10 mm, sewn around the edge.
Net colours: blue, black, green, beige.

Multicolour net: use for indoors only.

Option double floor

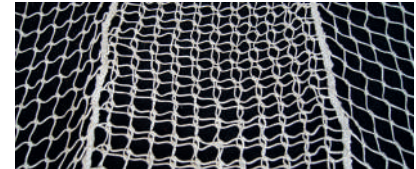

Climbing net knotted

Meshes: knotted square mesh.

- 250 mm: Ø 16 mm.
- 300 mm: Ø 20 mm.

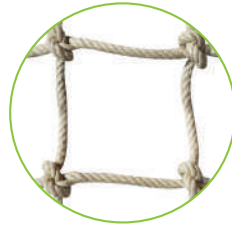
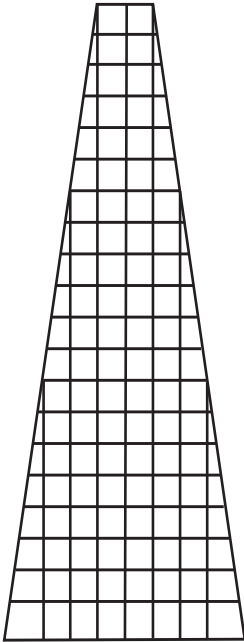

Different net shapes:
rectangular - trapeze -
circular.

Ropes: polypropylene,
textured polypropylene,
armed polypropylene.

Colors: green, blue, yellow,
beige or havana.

With ring at each corner angle.

Option: peripheral rope for fixing
the net.

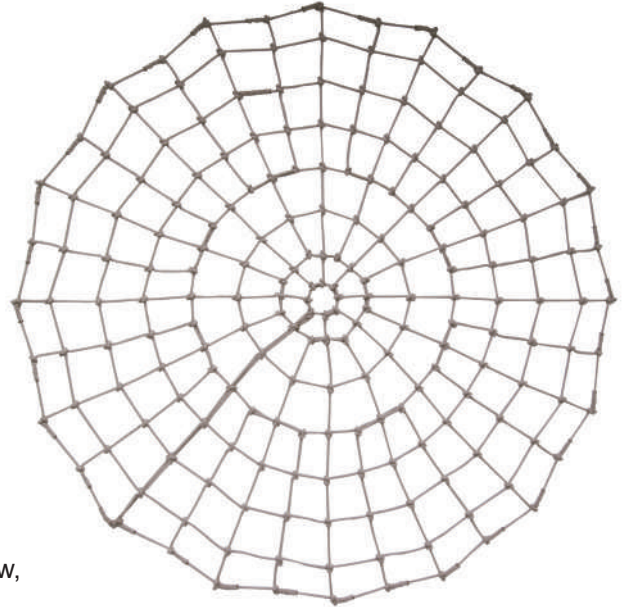

Kit chimney

Wooden square frame, with black non-slip exterior plywood half-bearing surrounded by 50 mm mesh netting. Kit for self-assembly.

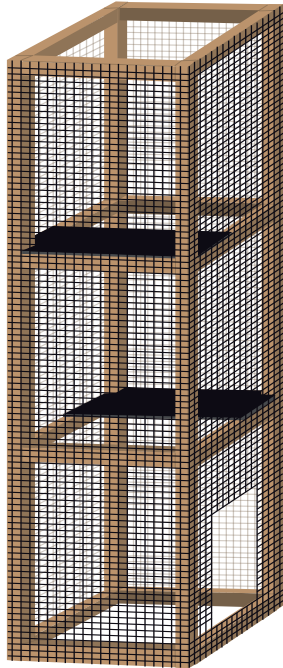

Net colours:
black, white,
yellow, blue,
green or red.



Level of difficulty

Wood chimney

Made of autoclave class 4 wood.
Composed of modules 115 cm x 78 cm x 99 cm high. Pre-assembled, to be fixed to the other module every meter.

Bottom, intermediary and bottom module supplied.

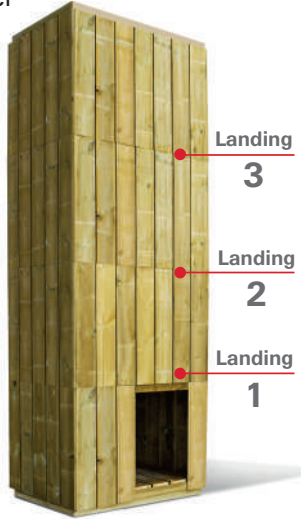

Level of difficulty

The chimney

Rope Ø 16 mm

- Square mesh 250 mm.
- Equipped with a half landing every meter.
- In rope Ø 12 mm, mesh 100 mm, attached in a staggered fashion. Color: black.
- Ø of the chimney: 800 mm. 1 m - 1,20 m on request.
- Colors: green or beige.

Supplied with half landing.

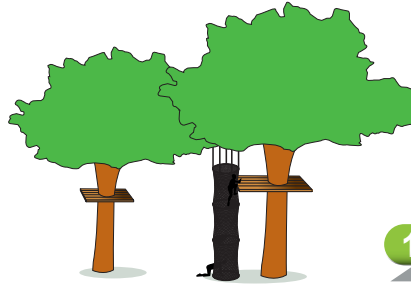

Level of difficulty



Safe vertical acces

Rope ladder

Beechwood bar Ø 30 mm and rope Ø 16 mm

- With thimble and suspension rings at both ends.

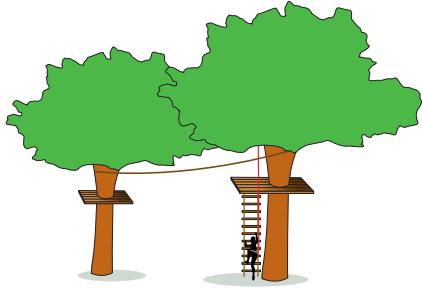

Color of the suspension rope green, beige, havana, blue, yellow or black.



Level of difficulty



Tarzan jump

Polypropylene textured rope Ø 30 mm.

- Thimble and suspension rings at the top.
- Reinforced grip at the bottom.

We can fix guides onto the rope for the implementation of safety measures.

Standard length: 3 m.

Additional meter on request.



Level of difficulty



The pencil

Class 4 autoclave wood colouring pencils painted.
To be fixed between two cables. Supplied with
assembly accessories.

Dimensions:

115 cm x Ø 6,5 cm.

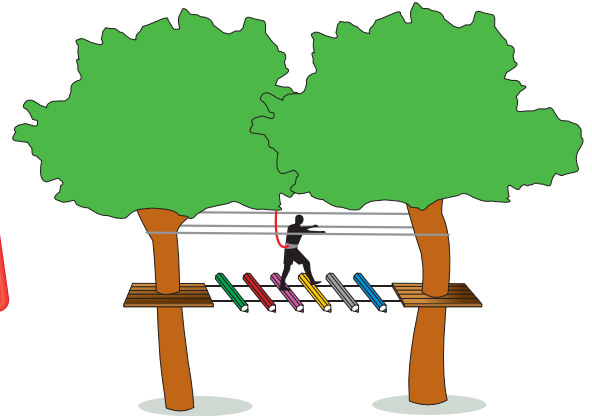

Colors:
red, blue,
orange, yellow,
green or pink.

**Cable
spacing**
75 cm.



Level of difficulty

The pastel

Ø 100 mm round post, in painted wood. To be fixed between two cables. Supplied with assembly accessories.

Dimensions:

115 cm x Ø 9,5 cm.

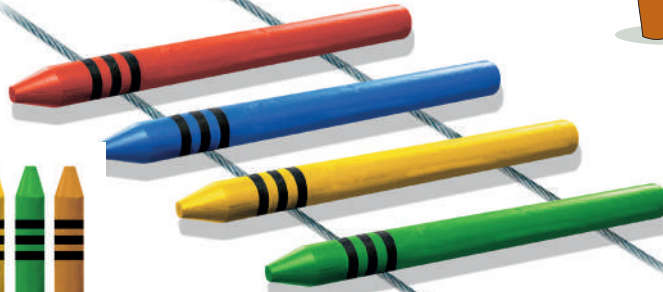
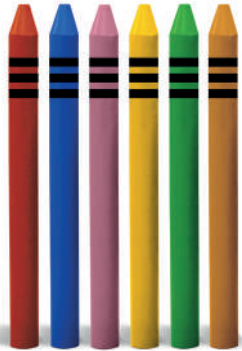
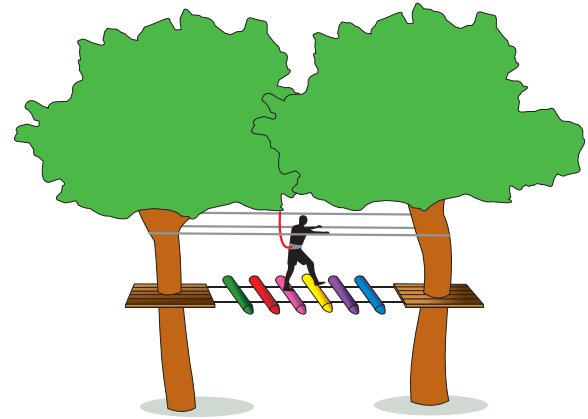

Colors:
red, blue,
orange, yellow,
green or pink.

**Cable
spacing**
75 cm.



Level of difficulty

Rubber

Foam rubber covered with blue and pink PVC, with wooden board to hold the module. Supplied with assembly accessories.

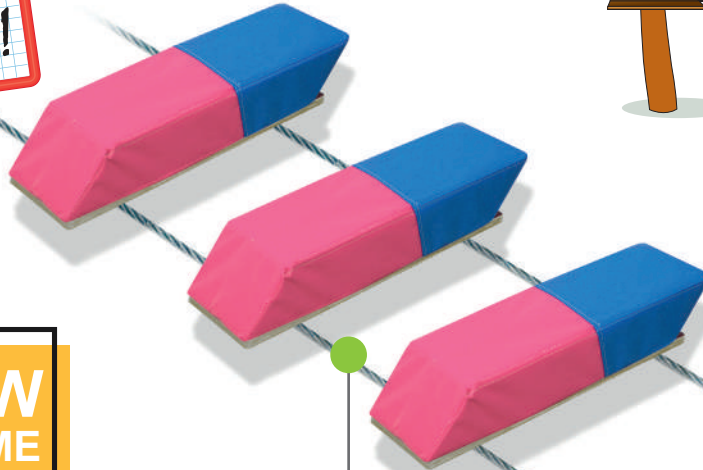

Cable
spacing
40 cm.

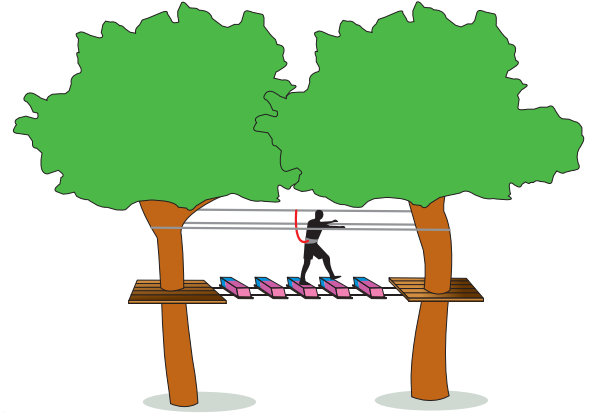

Dimensions:
50 cm x 20 cm.



Level of difficulty

Fountain pen

Non-slip exterior plywood in the shape of a feather. To be fixed lengthways, between two cables. Supplied with assembly accessories.

Dimensions: 75,5 cm x 28,5 cm.

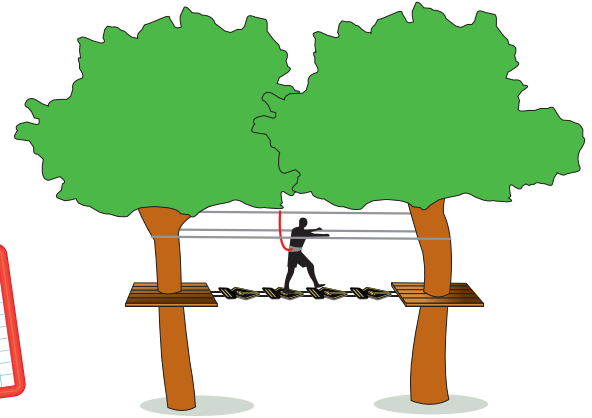

Colour
black.

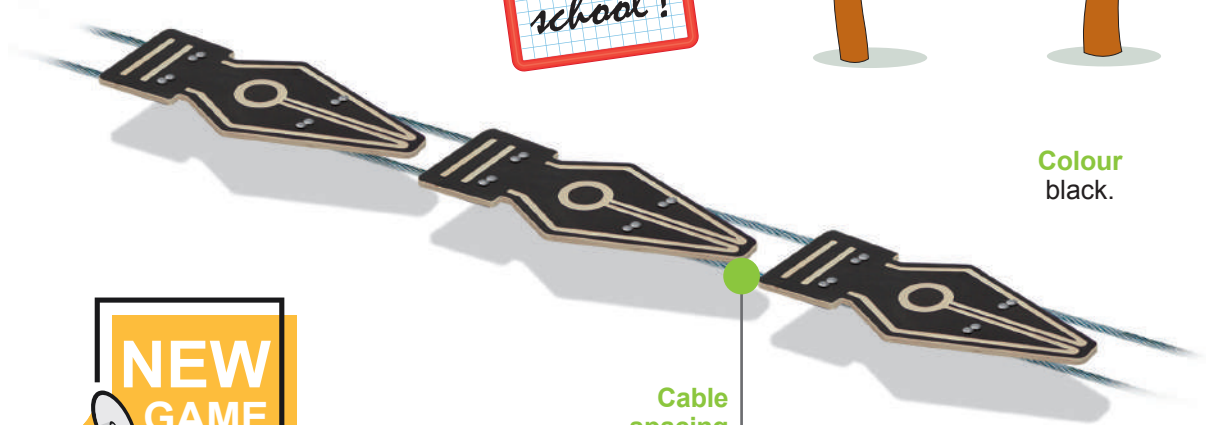

Cable spacing
13 cm.



Level of difficulty

Multiplication tables

Exterior plywood coloured non-slip multiplication boards. Choice of 9 multiples. Supplied with assembly accessories.

Dimensions: 100 cm x 50 cm.

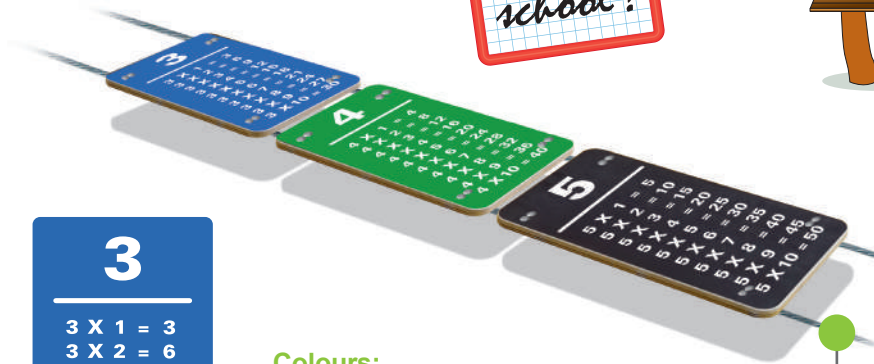
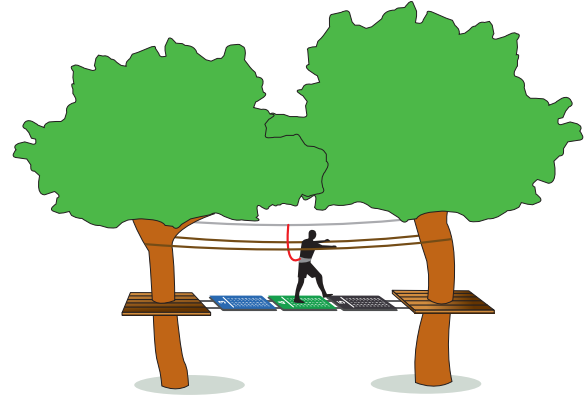

3

- $3 \times 1 = 3$
- $3 \times 2 = 6$
- $3 \times 3 = 9$
- $3 \times 4 = 12$
- $3 \times 5 = 15$
- $3 \times 6 = 18$
- $3 \times 7 = 21$
- $3 \times 8 = 24$
- $3 \times 9 = 27$
- $3 \times 10 = 30$

Colours:
red, blue,
yellow, green,
or black. Colour
is determined
by board.

**Cable
spacing**
40 cm.



Level of difficulty

Hoops

Ø 34 mm metal tube hoop with 4 attachment rings at the ends. Hoop diameter: 1 m.
Colours: green, red, blue or yellow.

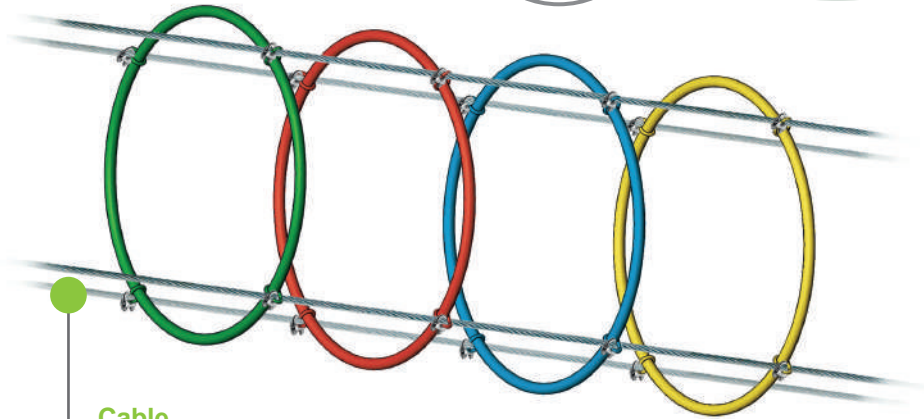
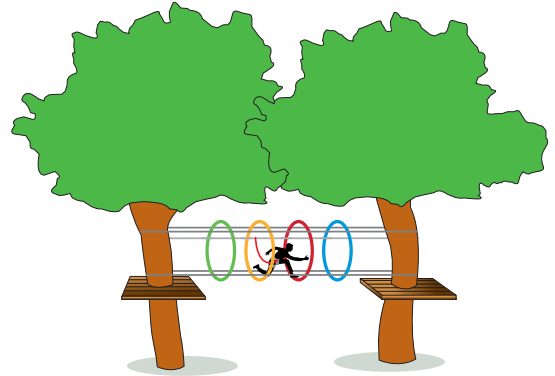

Cable spacing:
1 m.



The beehive

Yellow non-slip exterior plywood, engraved and stained, thickness 15 mm. Supplied with mounting accessories.

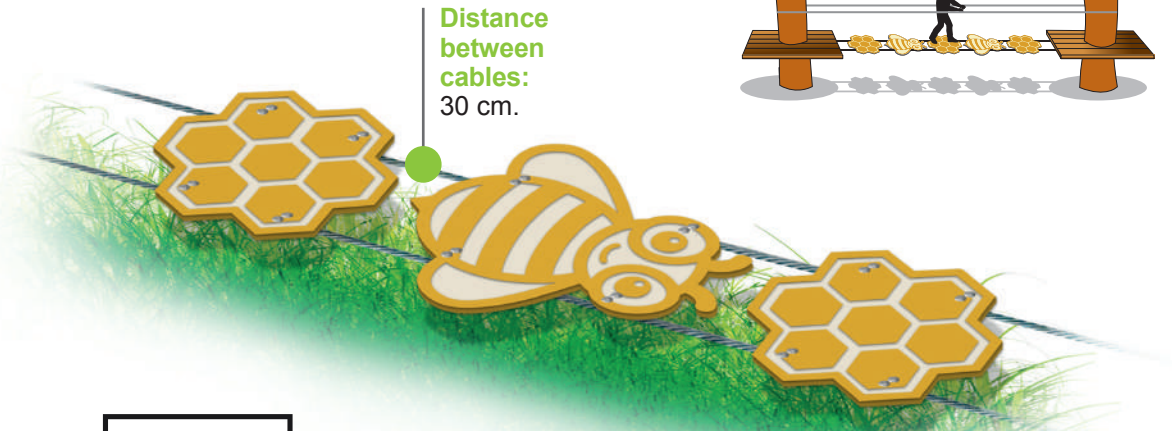

Level of difficulty

Flying plate

Wood frame, Class 4 autoclave, 4 cm thick, with a coloured non-slip exterior plywood disc, fixed on 2 Ø 16 mm black metal reinforced ropes. To be installed on two cables. Supplied with mounting accessories.

Dimensions: 70 cm x 70 cm.

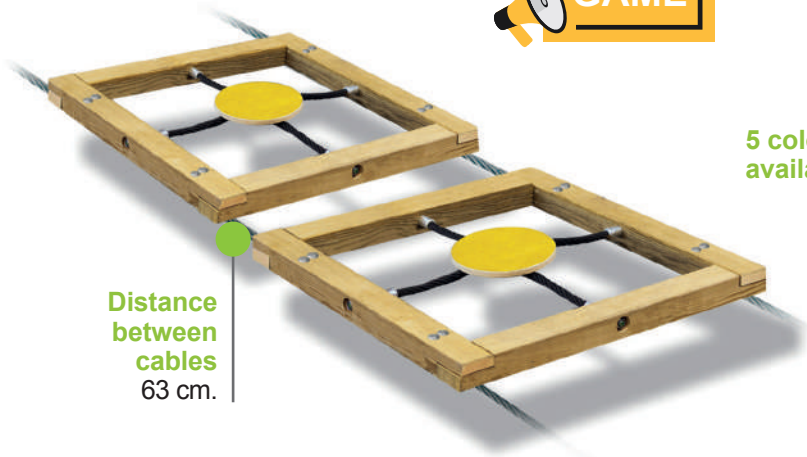
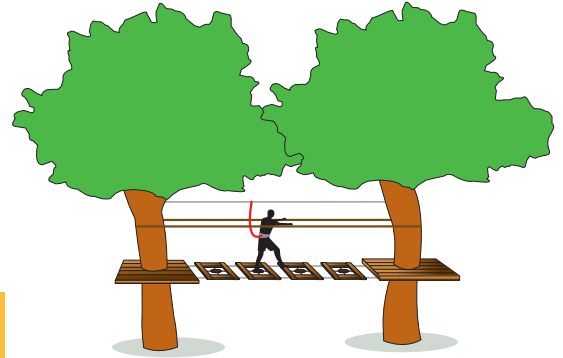

Distance between cables
63 cm.

5 colours available.

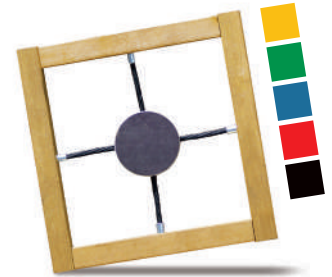

Level of difficulty

Big foot

Foot-shaped non-slip oor, attached to 2 logs
 Ø 100 mm. Positioning of 2 cables parallel
 to the left and right of the game module.

Colors yellow, red, green,
 blue ou black.

Length:
 121 cm.

Width:
 63 cm.

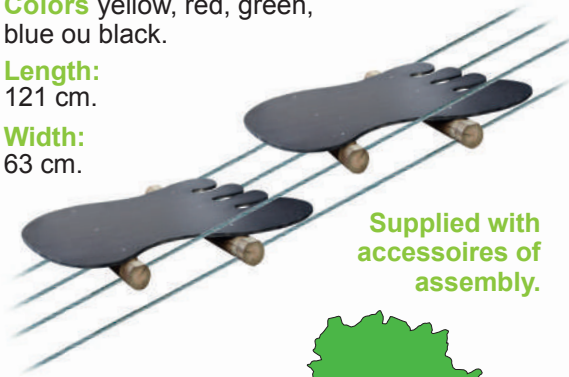

Supplied with
 accessoires of
 assembly.

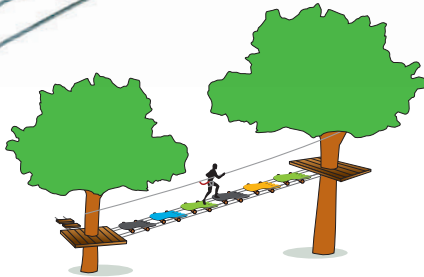

To ease the access
 to the upper level platform.



Level of difficulty

Running log

Log Ø 120 mm.

- Treated timber class 4.
- Equipped with ball bearings and rings
 for attachment to cable support.

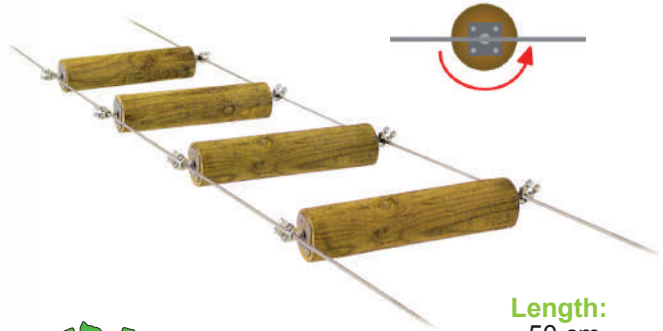

Length:
 50 cm.

**Cable
 spacing:**
 56 cm.

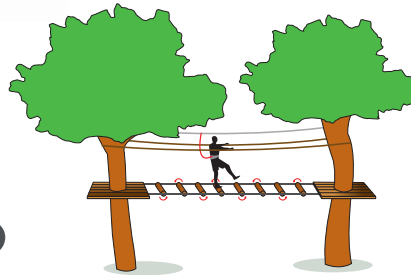

Level of difficulty

Pirogue bridge

Concave plank, treated autoclave class 4, 36 mm thickness, to put on 2 cables. Each plank comes with 4 wire rope tighteners.

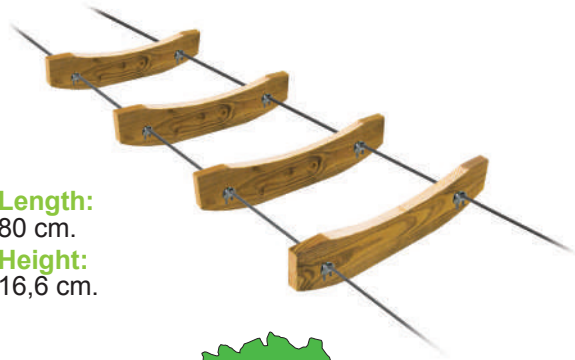

Length:
80 cm.
Height:
16,6 cm.

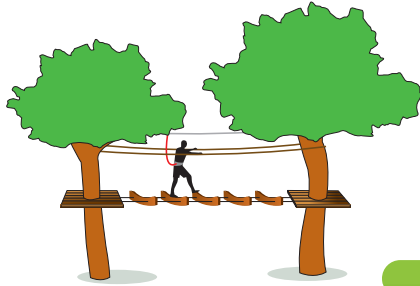

Level of difficulty

The piano

Made of autoclave class 4. Equipped with a counter-weight with a design of piano.

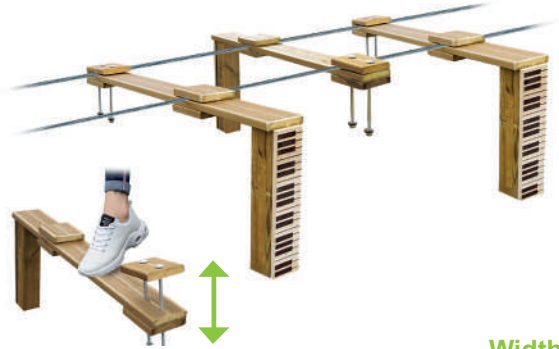

Width:
14,5 cm.
Length:
110 cm.
Cable spacing:
65 cm.

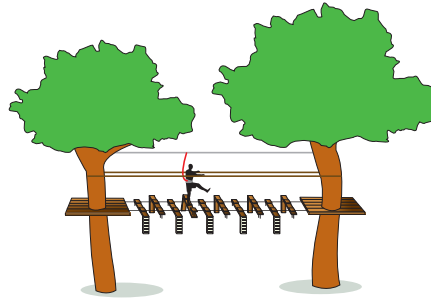

Level of difficulty

The pommel horse



This kit consists of:

- 1/2 circle Ø 500 mm.
- 10 pre-drilled planks autoclave treated, class 4. Length: 1 m.
- Comes with the required assembly accessories.

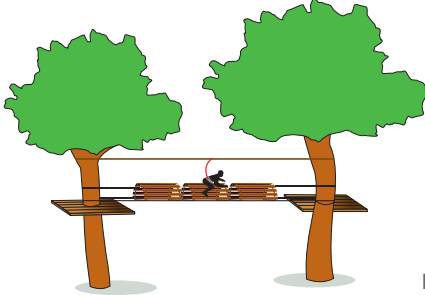

Moving bridge

2 m wood element composed of:

- 4 straps width 50 mm.
- 2 wood logs Ø 100 mm + threaded rod Ø 16 mm.
- 2 fixation rings at each end.

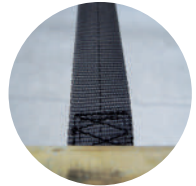
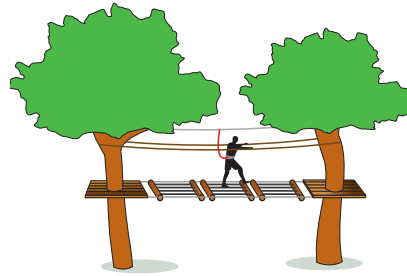

Sewn strap around the threaded rod.



Color black.



Colorful plank footbridge

Red, Yellow, blue, green, black non-slip exterior plywood birch planks. Thickness 15 mm. Dimensions: 500 mm x 145 mm.

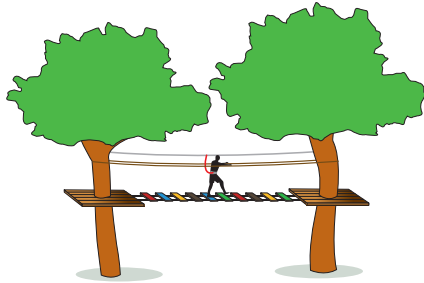
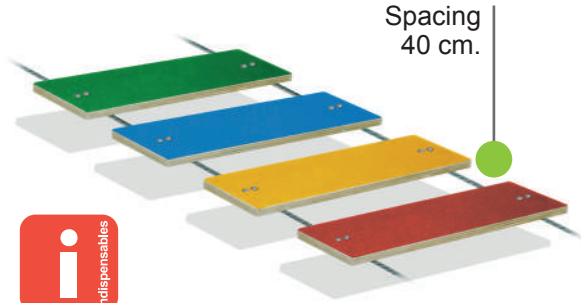

Level of difficulty

Colorful Chinese footbridge

Red, Yellow, blue, green, black non-slip exterior plywood birch planks. Thickness 15 mm. Dimensions: 50 mm x 145 mm.

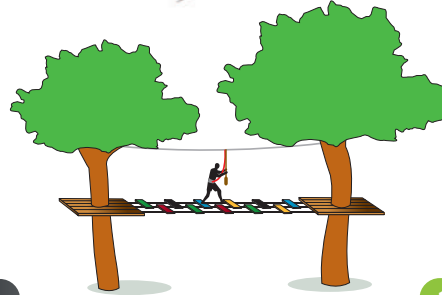
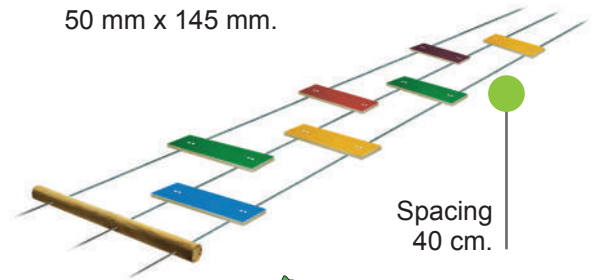

Level of difficulty

The trap

Circular CTBX birch plywood trap door with a hinged spring and a backup rope. Board of Ø 500 mm to be installed on 2 wire cables. Supplied with assembly accessories.

Spacing
30 cm.

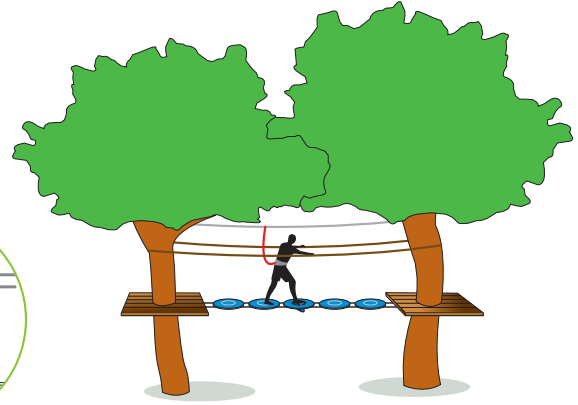
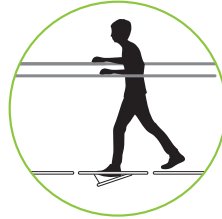
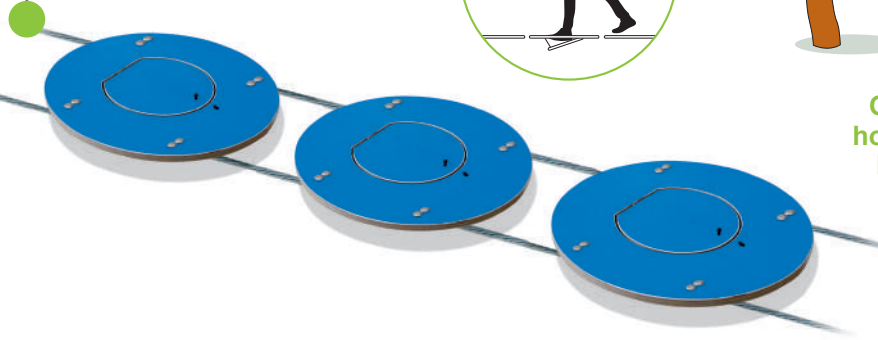

Opening
hold by the
backup



Color black, green,
red, blue, yellow.



Level of difficulty

Short hops

2 logs Ø 100 mm.

- Treated Timber class 4.
- Equipped with a non-slip disc Ø 600 mm.
- Necessary assembly accessories.



Hand rope

textured polypropylene Ø 20 mm with thimble and suspension ring at the top and a reinforced grip at the bottom.

Discs colors

green, black, blue or yellow.

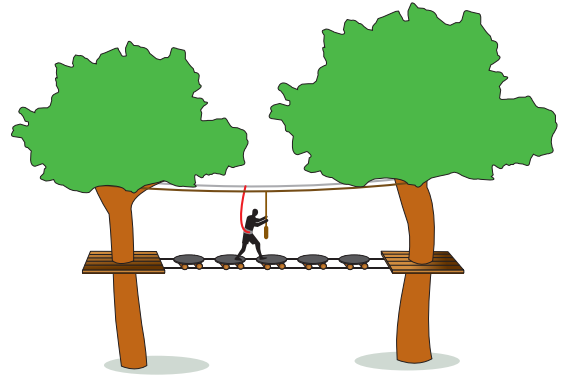

We can also supply circular non-slip discs.

Available diameters:
Ø 400 ■ 600 ■ 800 mm.

Thickness: 15 mm.

Colors

black, green, red, blue or yellow.



Level of difficulty

Fun islands planks

These wooden planks are a fun and educational game designed to enrich children's knowledge by discovering the forest: animal tracks, foliage, birds, etc...

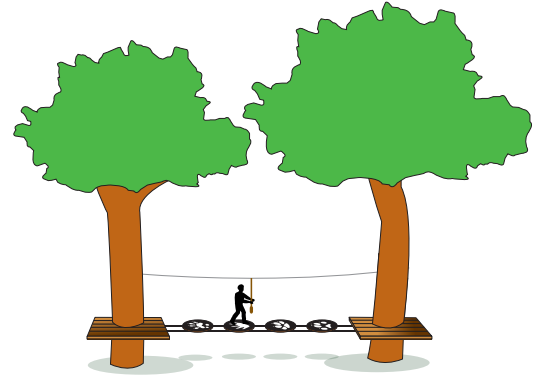

Description

non-slip exterior plywood,
thickness 15 mm

Ø of the plank: 500 mm

To fix on 2 parallel
wire rope.

With assembly
accessories.

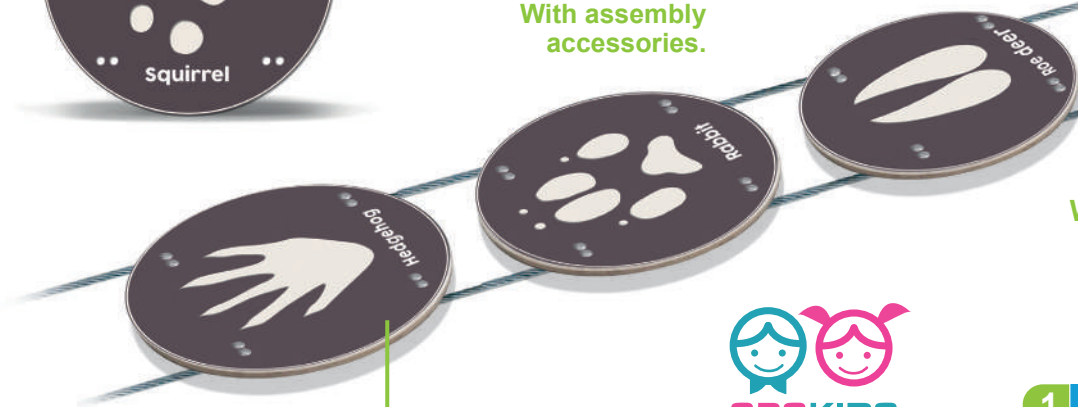

Wire cable
spacing
30 cm.

Laser engraving
on CTBX wood.



Discovery

The World of Wizards



Ocean

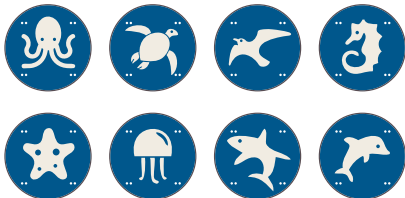

Magic



Pirate



Halloween



Chinese



Nature

Footprints



Foliages



Birds



Broken planks

Made of CTBX plywood, engraved and stained, thickness: 15 mm. The crack is engraved. To be placed on 2 wire cables.

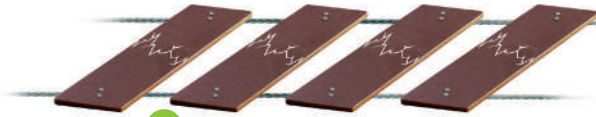

Wire cable spacing
45 cm.

Supplied with
assembly
accessories.

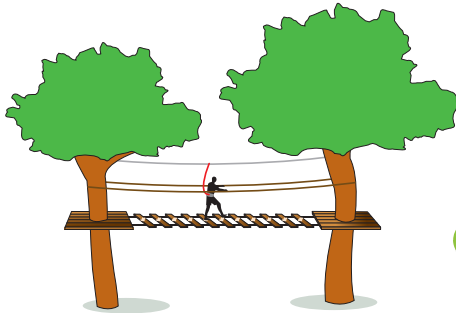

The Puzzle

Board made of CTBX exterior plywood in shape of piece of puzzle to be fixed on 2 wire cables including assembly accessories. Colors blue, black, green or yellow.

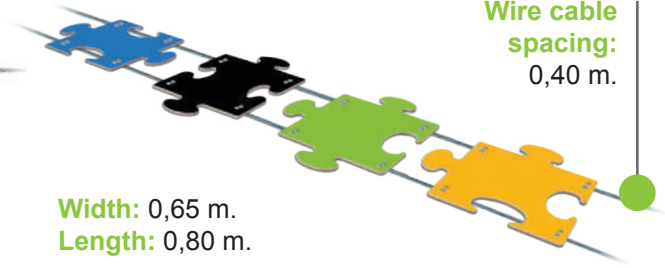

Wire cable
spacing:
0,40 m.

Width: 0,65 m.
Length: 0,80 m.

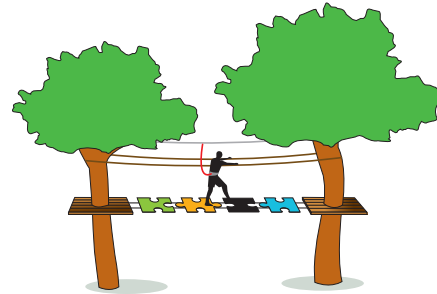

Halloween Collection

Plank made of engraved and varnished non-slip exterior plywood supplied with assembly accessories. The collection is currently composed of **5 elements**: bat, pumpkin, bone, ghost, skull.



Wire cable spacing: 0,40 m.

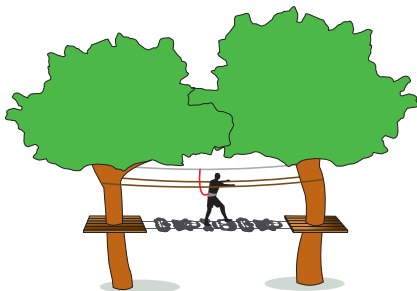

Level of difficulty

Smileys

Smiley designed from yellow or red CTBX birch plywood. Non-slip board, engraved, painted and stained. Installed on 2 wire cables. Diameter of the board: 500 mm. Spacing 30 cm.



1 smiley = 1 emotion

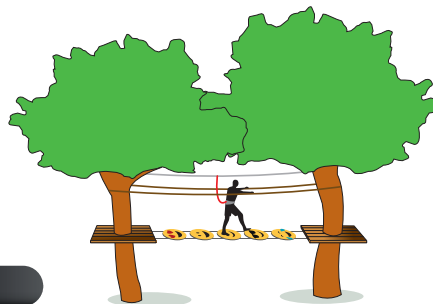
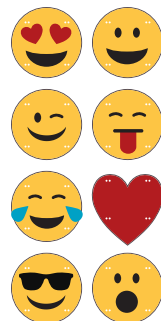

Level of difficulty

Candies

Collection of candies, made from colorful, engraved, painted and stained non-slip exterior birch plywood. Thickness 15 mm. Installed on 2 wire cables, supplied with assembly accessories.



Spacing
30 cm.

7 shapes:
Liquorice,
crocodile,
bublizz,
egg,
gummy
bear,
coke or
banana.

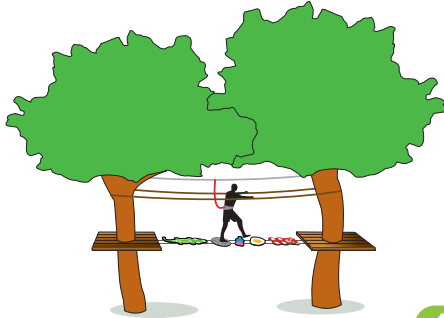

Level of difficulty

Chocolate planks

Non-slip exterior black plywood, engraved and stained, thickness 15 mm. To be installed on 2 wire cables. Supplied with assembly accessories. Dimensions: 50 x 60 cm.

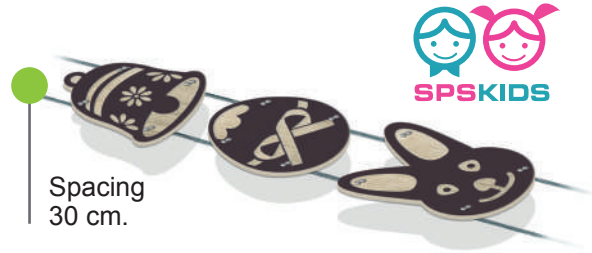

Spacing
30 cm.

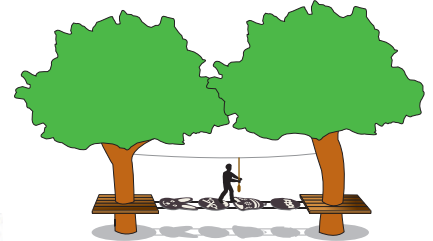

Level of difficulty

The slate

Class 4 autoclave wood frame with non-slip exterior plywood in the middle. Supplied with fixing accessories.

Dimensions: 49,50 cm x 35 cm.



Suspension ropes length:
1 m ■ 2 m
2,50 m.

Supplied with Ø 16 mm suspension ropes in polypropylene or textured Length 3 m. Self-assembly.



Can be used as a suspended or walk-on module

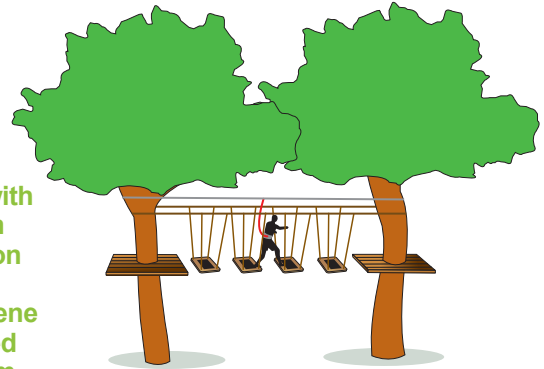

Cable spacing 40 cm.

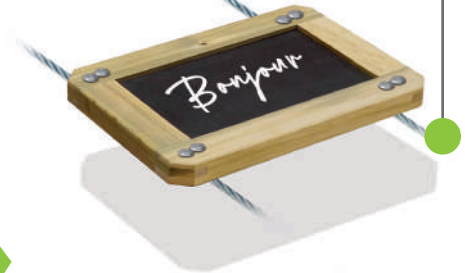

Level of difficulty

The Waffle

Module made of 30 mm class 3 Okoumé plywood, rectangular shape with hollowed-out grid.

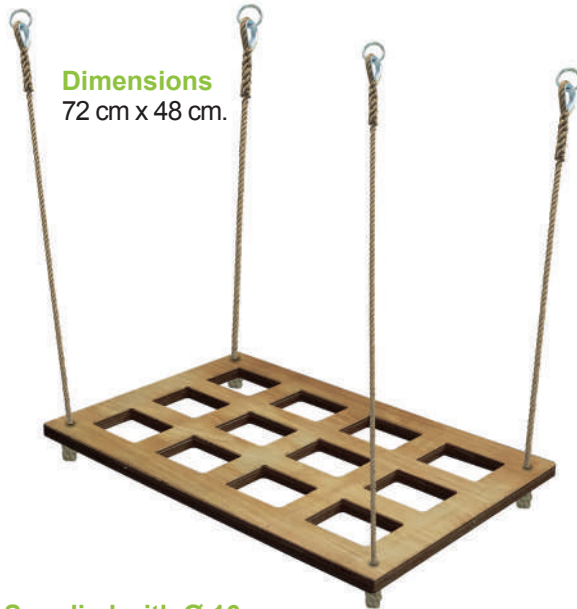

Dimensions
72 cm x 48 cm.

Supplied with Ø 16 mm suspension ropes in polypropylene or textured polypropylene.

Length suspension rope:
1 m ■ 2 m ■ 2,50 m.

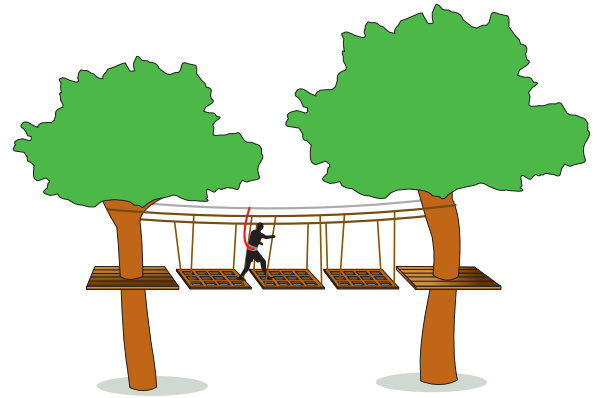

Supplied with assembly accessories.

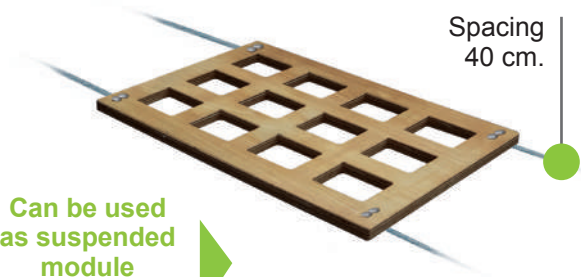

Spacing
40 cm.

Can be used as suspended module or walking obstacle



Level of difficulty

The goki plank

Coloured non-slip exterior plywood, 15 mm thick, with geometric inserts. Equipped with coloured suspension ropes 3m long

Dimensions: 61 cm x 118 cm.



Cable spacing 50 cm.

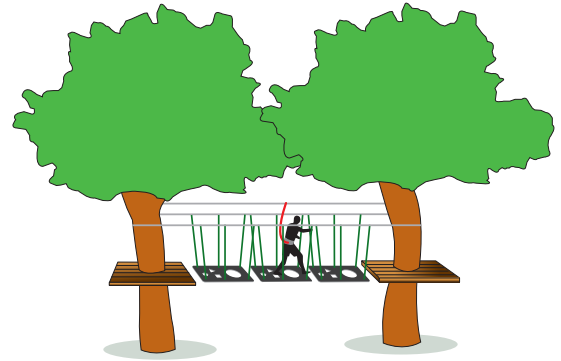

Colors: red, blue, green, black, and yellow.



Level of difficulty

Double walking log

Wood module, Class 4 autoclave, equipped with two Ø 120 mm logs, length 300 mm, and a grooved board, length 550 mm, 27 mm thick.

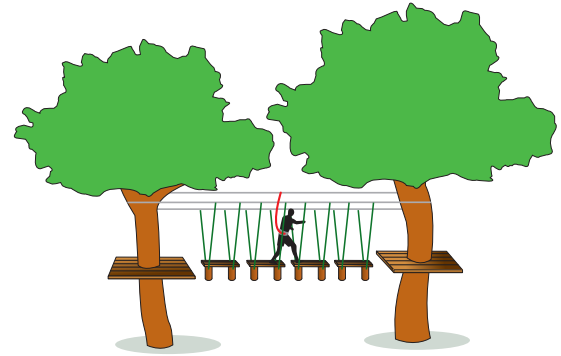

Dimensions:
Length 55 cm.
Width 15 cm.
Height 65 cm.

Available Rope lengths: 1 m
■ 2 m ■ 2,50 m.

Equipped with 4 coloured
Ø 16 mm suspension ropes.



Level of difficulty

Hanging I's ▼

Necessary accessories to attach the logs together.



Moving log ▶

Standard lengths:
1,50 m or 2 m.



Hell's crossing ◀

Equipped with
3 suspension ropes
Ø 16 mm.



Log trapeze ◀

Equipped with
2 suspension ropes
Ø 16 mm.

Log: 0,66 m, 1,33 m
or 2 m, for front or side
positioning.



Log Ø 100 mm. Treated Timber class 4. With thimble and suspension rings at the top.

Colors green, beige, havana, blue, yellow or black. Suspension lengths: 1 m ■ 2 m ■ 2,50 m.

Hanging skittles

Equipped with 2 suspension ropes \varnothing 16 mm.

Suspension lengths:

1 m ■ 2 m ■ 2,50 m.

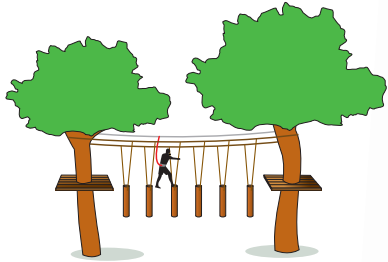

Log \varnothing 100 mm

Treated Timber class 4.

Log length: 0,66 m.

With thimble and suspension ring at the top.

Ropes colors: green, beige, havana, blue, yellow or black.



Level of difficulty



Colored hanging plate

Disc \varnothing 400 mm

■ Non-slip exterior birch plywood.

■ Textured polypropylene rope \varnothing 20 mm with thimble and suspension ring at the top.

Suspension lengths: 1 m ■ 2 m ■ 2,50 m.



Colors black, green, red, blue and yellow.



Level of difficulty

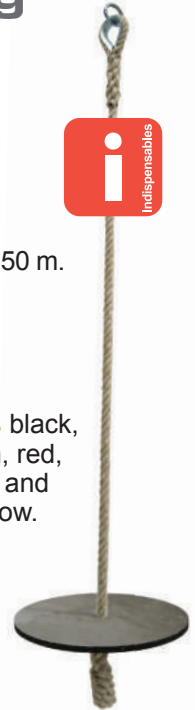

Indispensables

Hanging anchors

Log Ø 100 mm

Treated Timber class 4.
Log length: 0,66 m. With reinforced loop and suspension ring at the top. Ropes colors: green, beige, havana, blue, yellow or black.

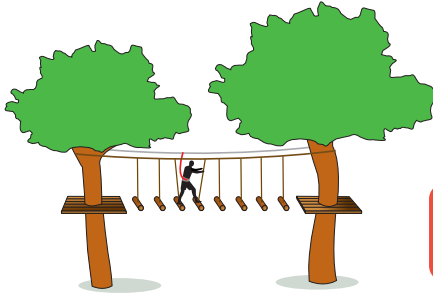

Equipped with suspension rope Ø 20 mm.

Suspension lengths:

1 m ■ 2 m ■ 2,50 m.



Level of difficulty

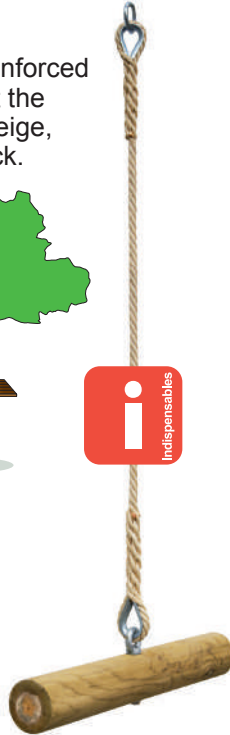

Vertical log

Log Ø 120 mm

- Treated Timber class 4.
- Step attached to the log.
- Armed suspension rope Ø 16 mm with thimble and suspension ring at the top.
- Colors green or beige.



Log length: 1,80 m.

Length with suspension rope: 2,50 m.



Level of difficulty



Flying carpet

Grooved planks

Treated Timber class 4. Equipped with suspension ropes \varnothing 20 mm. With reinforced loop and suspension rings at the top (to be assembled in a sawtooth fashion).



Thickness: 27 mm.

Width: 145 mm.

Full length: 1,50 m.

Length between ropes: 1,30 m.



Level of difficulty

Tibetan bridge

Made with a walking rope in textured polypropylene \varnothing 30 mm, equipped with suspension ropes every 0,5 m textured polypropylene \varnothing 20 mm.

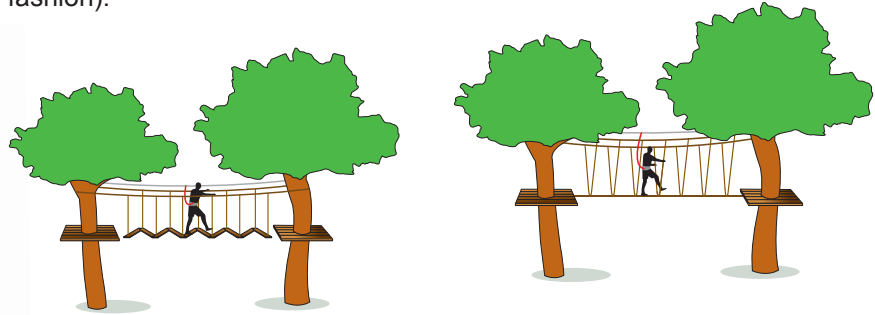

Suspension lengths:

1 m ■ 2 m ■ 2,50 m.

Colors green, beige, havana, blue, yellow or black.



With reinforced loop and suspensions rings.



Level of difficulty

Hanging crosses

Log: length 1,33 m, Ø 100 mm.

- Treated Timber class 4.
- Equipped with 4 suspension ropes Ø 16 mm.
- With reinforced rope and loop suspensions at the top.

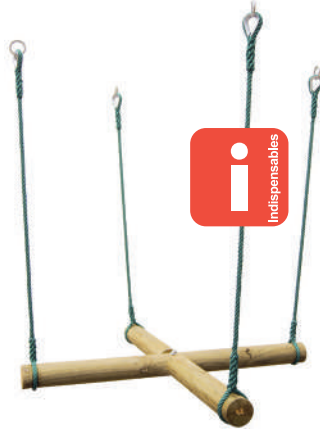

Suspension lengths:

1 m ■ 2 m ■ 2,50 m.

Colors

green, beige, havana, blue, yellow or black.

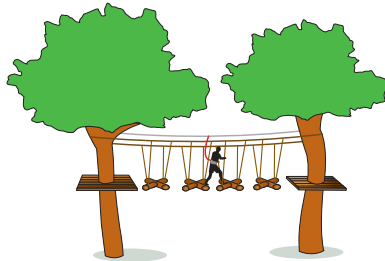

Level of difficulty

Hanging bridge

Grooved planks with logs:

length 0,66 m
Ø 100 mm.

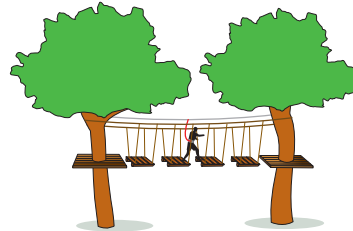

Level of difficulty

The net tube

Net tube

Equipped with a steel circle
Ø 800 mm every meter.

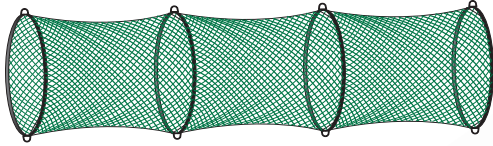

Different meshes available:

- Polyamide, mesh 50 mm.
- Colors white or black.
- Polyester, mesh 50 mm.
- Colors blue, yellow, green, beige or red.
- Polyethylene, double mesh 70 mm.
- Color green.
- Rope, mesh 250 mm.
- Color green or beige.



Option:
or more comfort
you can add a
mattress (pad).

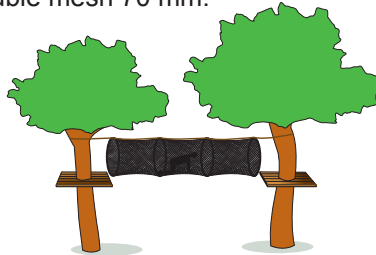

Level of difficulty

Swing seat

Consists of 2 steel structures, grey color.
Supplied with 4 grooved boards.
Length: 1,50 m.



Possibility to buy only
the structure.



**Dimensions
of structure:**
1 m high by
0,80 m wide.

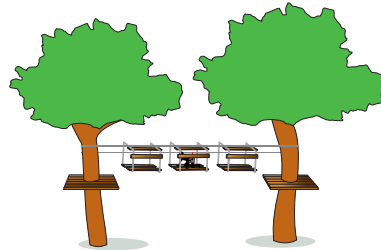

Comes with
assembly
tools.



Level of difficulty

The honey spoon

Obstacle consisting of a \varnothing 100 mm autoclave class 4 post with a \varnothing 250 mm honeycomb larch base and a \varnothing 16 mm reinforced suspension rope crimped at each end, equipped with a thimble and fixing ring.

Total
height:
150 cm.

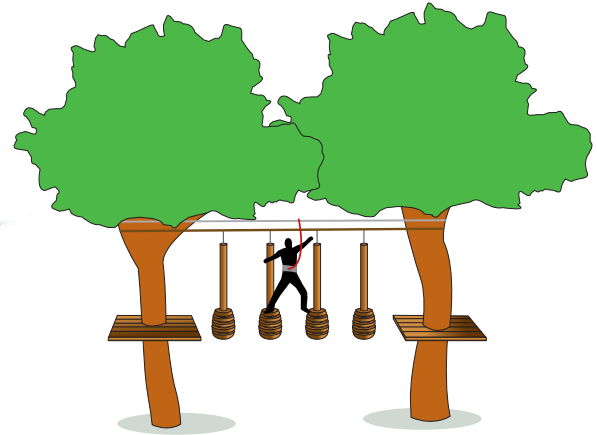

Level of difficulty

Balance pole

Steel bar Ø 34 mm

Equipped with 2 suspension ropes
Ø 16 mm. Connected at the top
with a ring.

Colors

green or beige.

**Sold separately,
either element.**

Pulley with shackle



Tandem Speed
Pulley Petzl

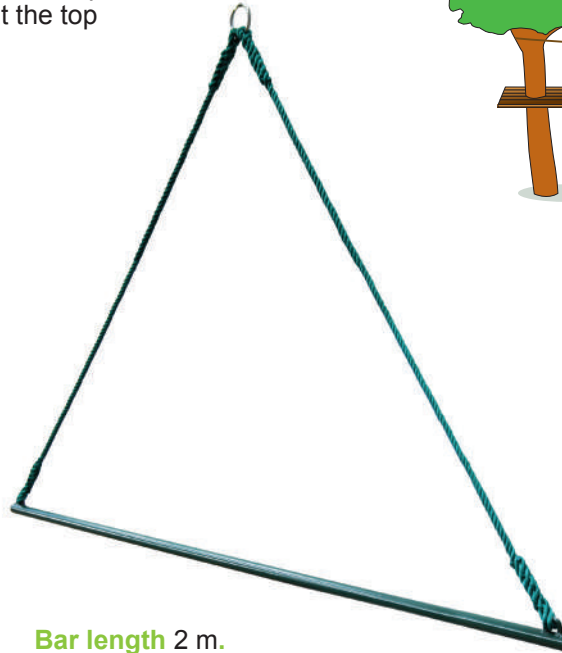

Bar length 2 m.

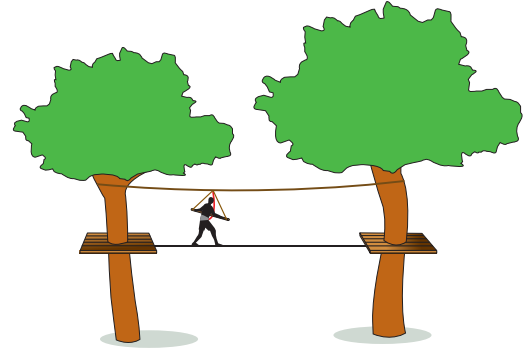

Level of difficulty

Jungle tunnel

Animals made of CTBX plywood, thickness 15 mm, engraved and stained. Path dimensions: 90 cm x 70 cm. Total dimensions: 1,22 m x 2,00 m.

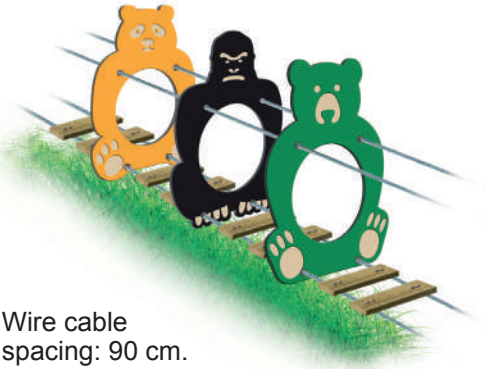

Wire cable spacing: 90 cm.

Colors: blue, yellow, green, red or black.

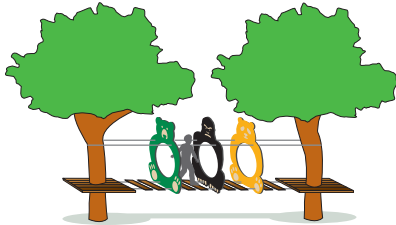

Level of difficulty

The Enchanted tunnel

Exterior birch plywood for outdoor use, fixed on 4 wire cables. Dimensions: 1,10 m x 1,10 m, thickness 15 mm.

Available different shapes

Rabbit, apple, pear, turtle, leaf, cloud, acorn...



Sold separately

Grooved wooden plank in autoclave class 4 pine Length: 1,10 m.

Cable spacing: 0,90 m.

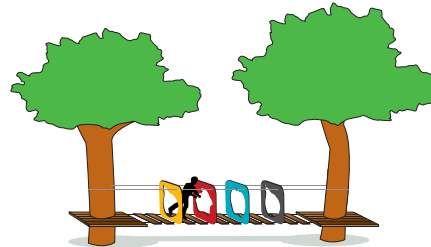

Level of difficulty

Open barrel

Circles Ø 800 mm with opening at the top to allow the continuous lifeline to pass through.
Class 4 autoclave boards, pre-drilled to length.

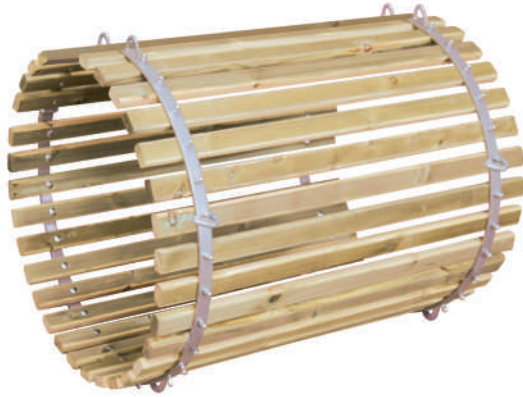

Barrel option

A mattress can be added for more comfort.

Standard lengths

- 1 m - 1,50 m
- 2 m - 2,50 m.

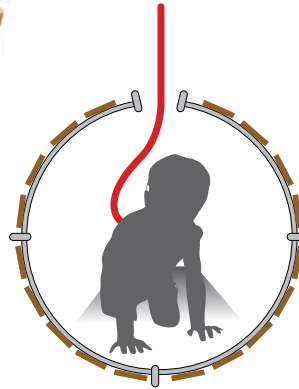
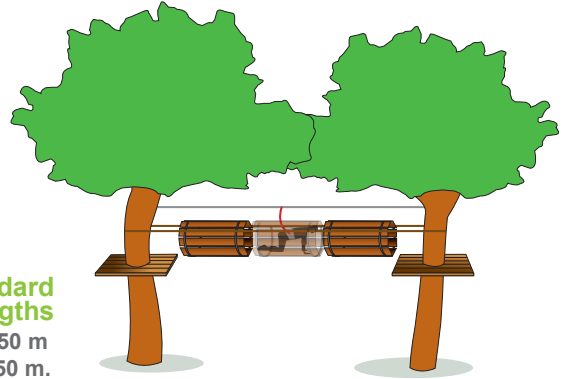

Level of difficulty

Barrel

Composing:

Circles Ø 800 mm. Wooden slats, treated timber class 4, pre-drilled with regardsto length required.

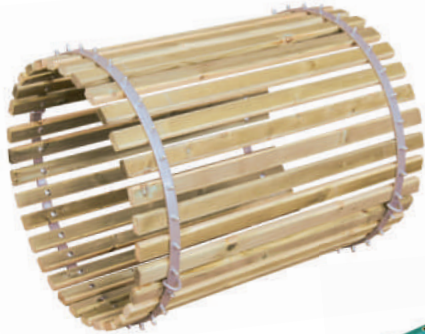

Standard lengths
1 m - 1,50 m
2 m - 2,50 m.

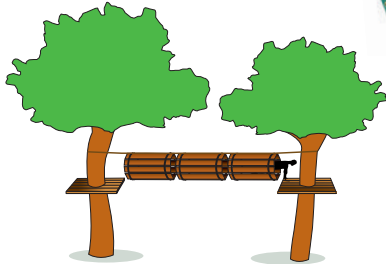

Barrel option

A mattress can be added for more comfort.



Level of difficulty

The wave

Wave bridge, made with steel plate curved covered with gray plastic and fixed on grooved boards with bolts.



Sold as an 5,40 m element (double wave). Supplied with link accessories.

The gateway is equipped with a suspension ropes, Ø 16 mm, color green or beige. **Childrens course:** adujstable suspension ropes 1,50 m to 2 m.

Adults course: adujstable suspension ropes 2,50 to 3 m. Bridge width: 0,50 m.



Level of difficulty

Uneven circles

Steel circle Ø 1 m with a 30 cm tube welded to it.

Equipped with 2 plates welded to the circle for attaching the wire rope.

To be installed in a staggered fashion.

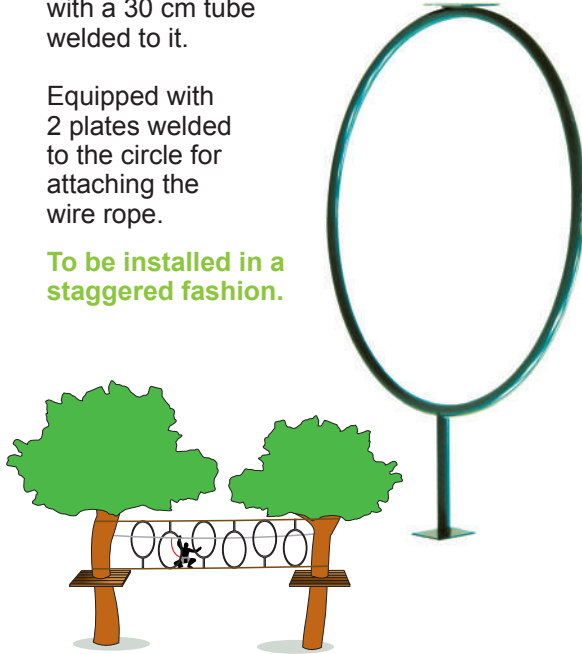

1
Level of difficulty

Bascule bridge

Wooden module treated class 4, length 2 m, made with a grooved wooden plank, attached to a hinge galvanized steel.



Place the bridge on 2 ropes with a spacing of 40 cm between them.

Supplied with assembly accessories.

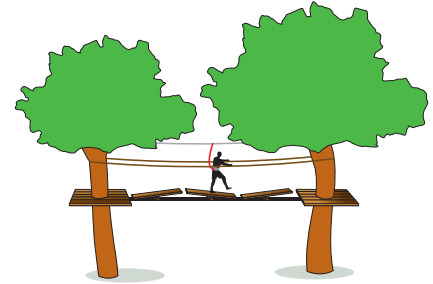
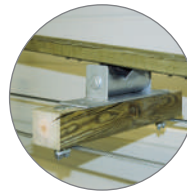

2
Level of difficulty

The Licorice Path

Made of exible rubber material width 250 mm, equipped with suspension ropes Ø 16 mm with thimble eye and suspension rope.

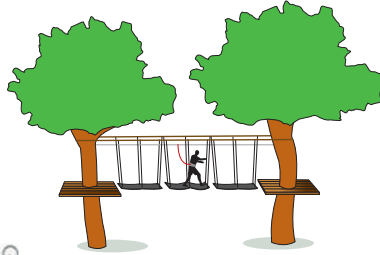

Minimum length: 2 m.

Colors of the suspension rope green, beige, havana, red, black, blue and yellow.



Level of difficulty

The Flex

Flexible rubber product to be fixed on two support cables.



Product description

- EPDM rubber.
- Triangular fixing rings.
- Reinforced with a metal plate inside.

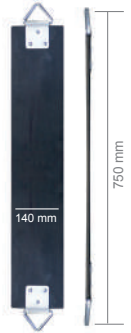

Level of difficulty

Hanging bridge

Apple and butter y shape

Non slip exterior birch plywood.
Thickness: 15 mm. Supplied with 4 suspension ropescolor green or beige in rope Ø 16 mm and thimble and suspension rings at the top.



Level of difficulty

Wooden island planks

Shape: apple, pear, fish, rabbit, turtle, leaf, cloud, acorn.

Non slip exterior birch plywood.
Thickness: 15 mm. With assembly accessories.

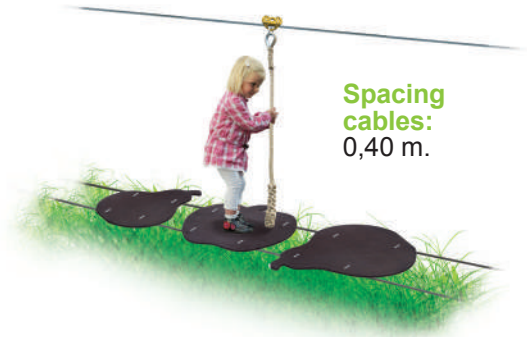

Spacing cables:
0,40 m.

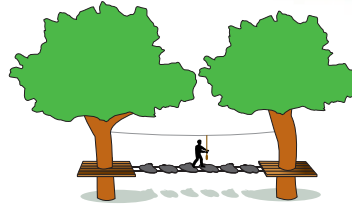

Level of difficulty

Handing bridge and wooden island planks: colors red, green, blue, yellow or black.

Rope loops

Rope Ø 16 mm

Standard length: 0,56 m.

Colors beige, yellow, blue or black.



Level of difficulty

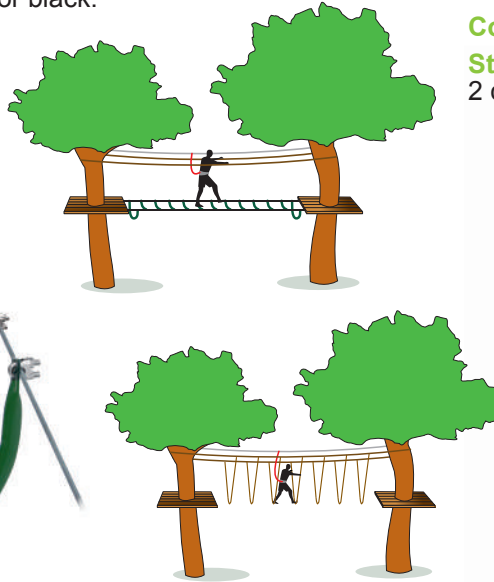

U-form rope

Rope Ø 20 mm

Reinforced suspension loops and rings at both ends.

Colors beige, blue, yellow or black.

Standard lengths:
2 or 4 m.



Level of difficulty

The “ravioli”

PVC ball enclosed in a black ravioli-shaped walking net. Net equipped with a ring at each corner. Not Supplied with rope tightener for assembly. Dimensions: 75 cm x 75 cm.

Net description

4,75 mm braid, 50 mm black mesh. With 10 mm stitched boltrope.

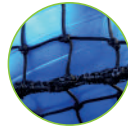

Ball
Ø 55 cm



Cable spacing
75 cm.

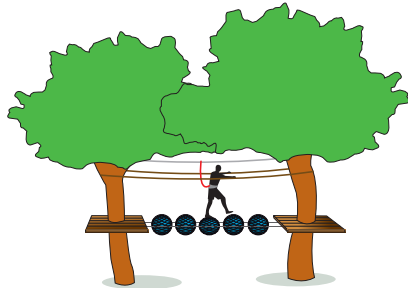

Color
blue or
red.



Level of difficulty

Pika Pika

A Ø 300 mm yellow sphere with two handles equipped with 2 polypropylene suspension ropes Ø 16 mm with thimble and suspension ring.

Length of suspension ropes: 2 m.



PVC stickers
anti-UV treated.

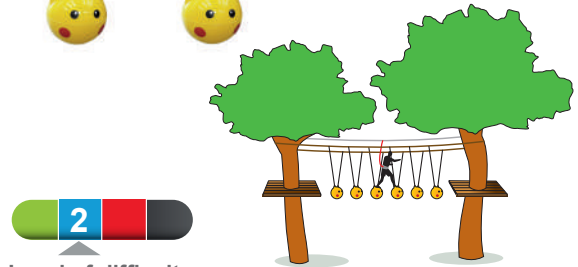

Level of difficulty



Minimum length: 2 m.

The sailor bridge

«Polyform» boat fender, length 60 cm. The fender is assembled on 2 x Ø 16 mm polypropylene ropes, color green or beige, with thimble eye and ring at each end.

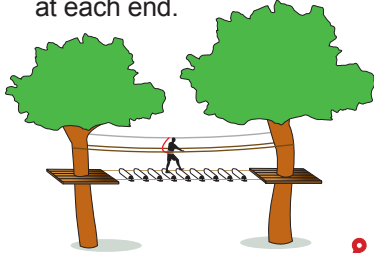

The pirate obstacles

«Polyform» boat fender, length 1 m. The fender is equipped with a Ø 12 mm elastic rope + a suspension ring at each end.

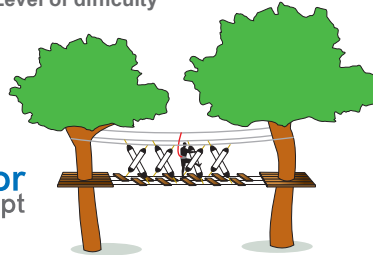
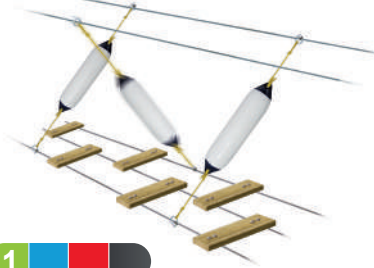

The ship's boy swing

«Polyform» boat fender, length 1 m. The fender is equipped with 2 x Ø 20 mm polypropylene ropes, color green or beige, with a thimble eye and ring at the top and a knot at the bottom.

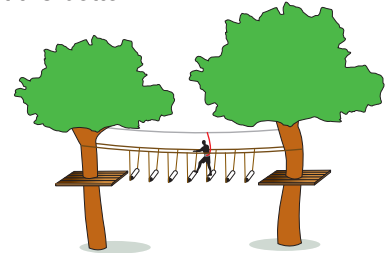

Color of the suspension rope: green, beige, havana, black, blue or yellow.

Rope rings

Thimble and suspension rings at the top.

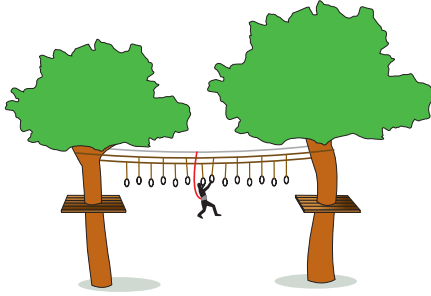

Ring Ø 200 mm at the bottom for hands

- Suspension rope Ø 16 mm.
- Colors beige, havana, blue, green, yellow or black.



Level of difficulty



Hanging stirrups

Thimble and ring suspension at the top.



Galvanised steel stirrups

- Suspension rope Ø 20 mm.
- Colors beige, havana, blue, green, yellow or black.



Level of difficulty



Climbing planks

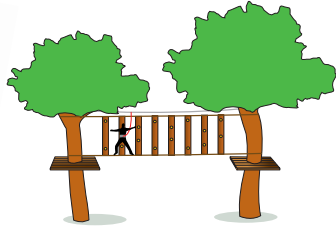

Plank

Thickness: 29 mm.

Width: 145 mm.

Plank height: 2 m.

Spacing of wire ropes: 1,90 m.

Treated Timber class 4. Equipped with 5 inserts, 2 climbing holds and the accessories to attach the plank to the 2 wire ropes.

The planks should be placed every 0,50 m or every 1 m.



Level of difficulty

Coco Tarzan

Polypropylene Monkey fist ball Ø 150 mm, equipped with a suspension rope Ø 16 mm with thimble and suspension ring at the top.

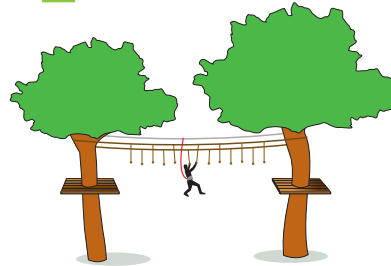

Level of difficulty

Foot obstacle

Foam obstacle covered with a PVC tarpaulin and equipped with Velcro to attach the obstacle to the plank.

Thickness plank: 27 cm.

Length: 90 cm.

Width: 27 cm.



Comes with the required assembly accessories.

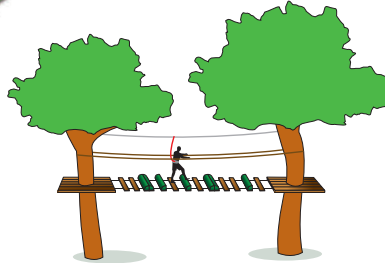

Level of difficulty

Smiley

Foam obstacle covered with a PVC tarpaulin, equipped with fixing eyelets in the upper part. The smiley is an adhesive sticker on the tarpaulin.

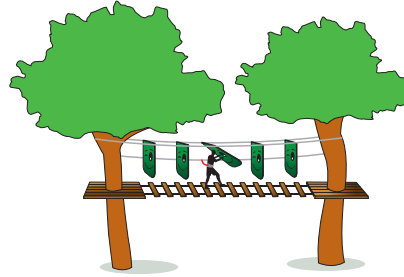

- Color green.
- Dimension: 1 m x 1,50 m.



Level of difficulty

Suspended fry

Foam cylinder covered with a green PVC protection, provided with 4 hanger straps sewn on a ring.

Standard color: green.

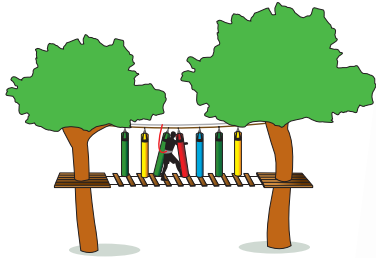

Foams length: 1,50 m.

Colors other on request.



Level of difficulty



TAC O TAC

Foam obstacle with a density of 30 kg/m³ and is covered with a PVC tarpaulin. Equipped with a polypropylene (synthetic hemp) suspension rope Ø 20 mm. Length 2,50 m.



Colors
blue,
orange,
yellow,
green
or red.



Level of difficulty

Jungle tracks

2 modules to create different games.

- Round steel tube Ø 800 mm. Color grey.
- Steel bar (tube) straight or curved.
- Mesh net size 100 mm, without knots, black polythene.
- Rope size Ø 12 mm.

Net without knots, diamond mesh.

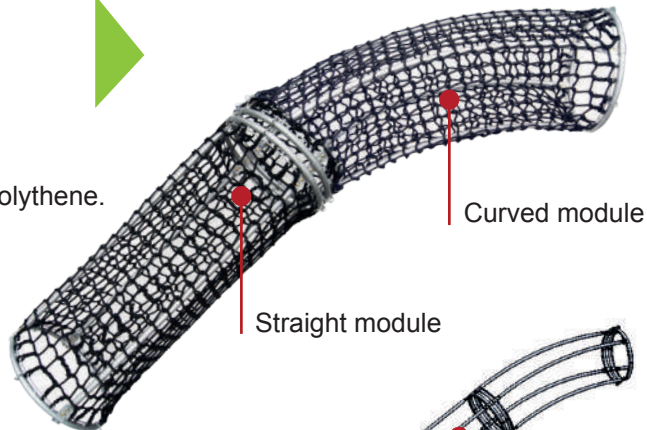
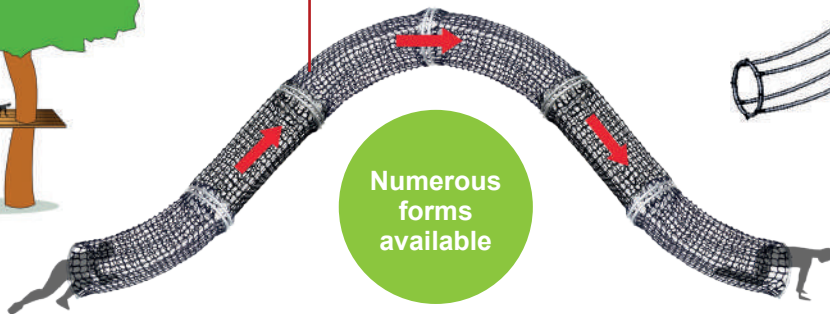
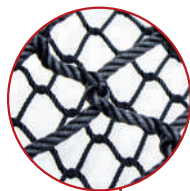

Curved module

Straight module

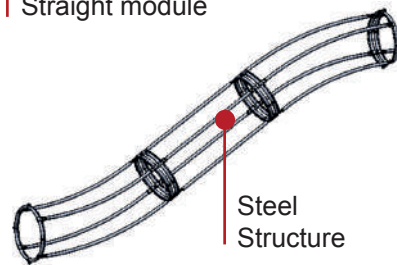

Steel Structure



Level of difficulty

Customizable course. Possible to be sold per unit.

Planks for bridge

Grooved Plexiglas XT planks supplied with the fixing accessories.

Width: 140 mm.
Thickness: 15 mm.
Length: 500 mm.



Level of difficulty

Chinese bridge "Glass Series"

Grooved and bolted plank in plexiglas XT to fix on 3 wire cables. Supplied with fixing accessories.

Option: 2 spreaders 1 m long with 3 drilled holes on edges.

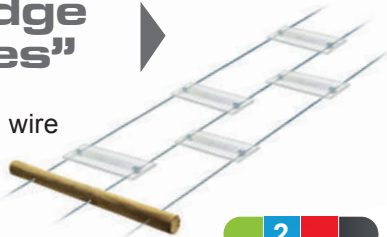

Level of difficulty

Funambulist planks for bridge

Grooved Plexiglas XT planks supplied with the fixing accessories.



Level of difficulty



Glass Series

Width: 140 mm.
Thickness: 15 mm.
Length: 1 m.



« Glass » plank bridge

Grooved plexiglas XT planks, fixed to 2 rafters 90 mm x 90 mm.

Length: 0,65 m.
Width: 0,63 m.

Length of suspension ropes: 1 m ■ 2 m ■ 2,50 m.

Equipped with 4 suspension ropes Ø 16 mm With wire rope thimbles and suspension rings in the upper part.



Level of difficulty



“Glass” barrel

This kit consists of:
 Ø 800 mm rings. Pre-drilled
 Plexiglass XT slats. Length: 1 m.

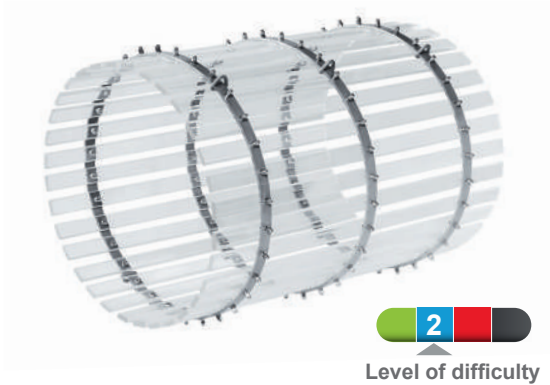

Pommel horse «Glass»

- Kit consists of:
- 1/2 circle Ø 500 mm.
 - 10 pre-drilled Plexiglas planks.
 - Assembly accessories.

«Glass» wave

Wave bridge, curved, made with steel and covered with grey plastic, on which grooved plexiglass XT planks are bolted.



The gateway is equipped with a suspension ropes, Ø 16 mm, color green or beige. Childrens course: adjustable suspension ropes 1,50 m to 2 m. Adults course: adjustable suspension ropes 2,50 to 3 m. Bridge width: 0,50 m.



Length: 1 m.
 Thickness: 15 mm.

Speed cube

Wooden cube with coloured non-slip exterior plywood panels forming a speed cube to be fixed to two parallel cables. Supplied with mounting accessories.

Dimensions:
50 cm x 50 cm.

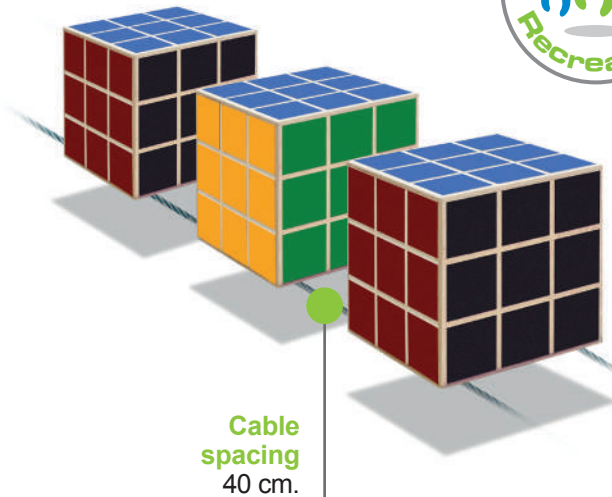

Cable spacing
40 cm.

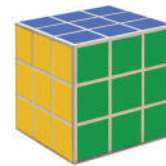
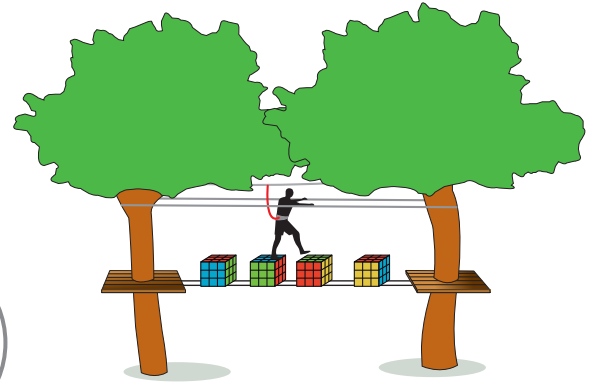

Front side



Rear side



Level of difficulty

Dice

Cubes made of Okoume plywood panels painted white with black dots for the numbers. Mounted on two rotating axes.

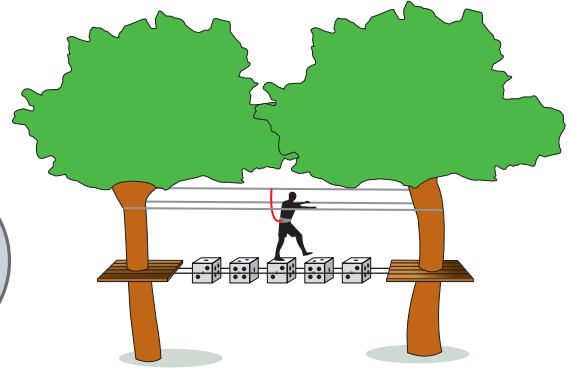
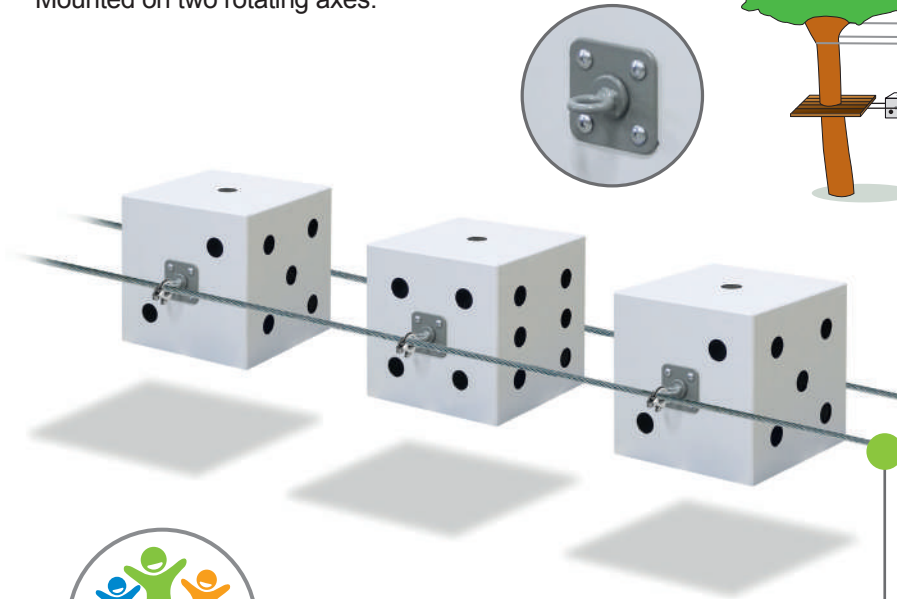

Dimensions:
30 cm x 30 cm.

Cable spacing:
40 cm.

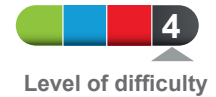

The bee cell

Tunnel made of 90 x 90 mm square wood and yellow bungee cords, diameter 12 mm. To be fixed with supplied wire rope saddles.

Dimensions:
1,18 x 1,35 m.

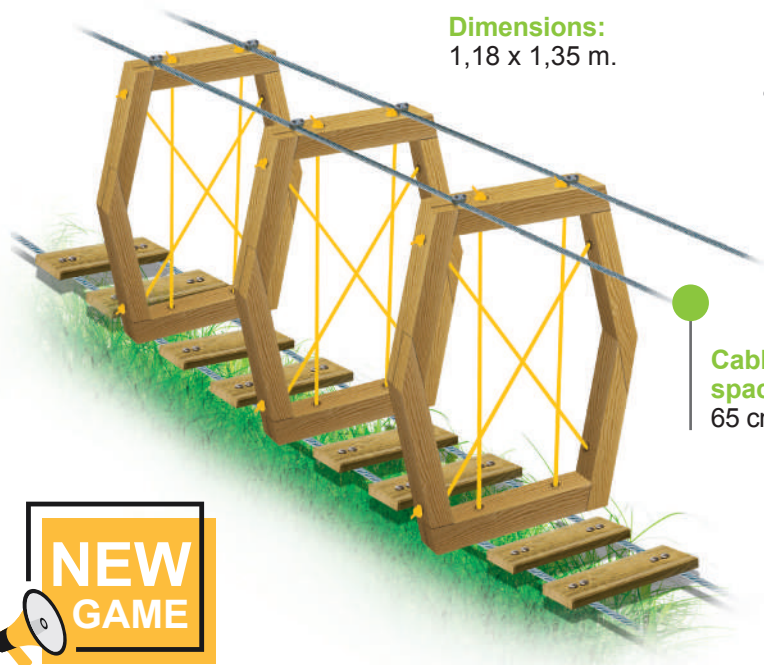

Cable spacing
65 cm.

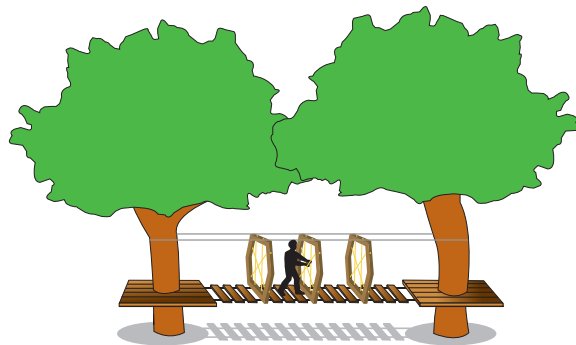

Sold separately
Specially designed
to fit the bee cell.



Bridge board
0,75 m.



Level of difficulty

Halloween Footbridge

Printing on Okoumé plywood, thickness 18 mm, Ø 500 mm. Installed on 2 wire cables. Supplied with assembly accessories.

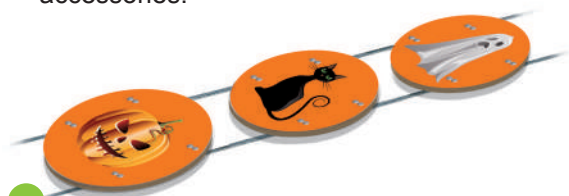

Spacing
30 cm.

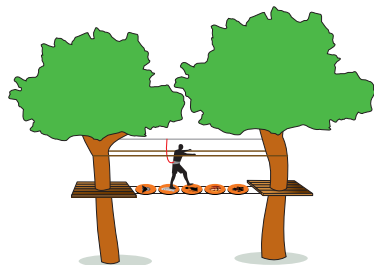

Level of difficulty

Mushroom Picking Collection

Black, red, yellow, green or blue mushroom made of CTBX birch plywood. Engraved, and stained non-slip planks. Installed on 2 wire cables. Supplied with assembly accessories.

Dimensions: around 65 cm x 85 cm.



Spacing
30 cm.

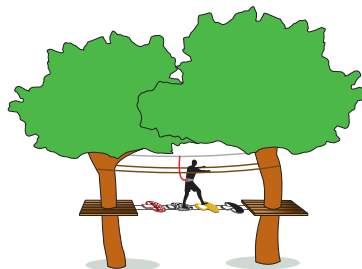

Level of difficulty

The Farm collection

Made of CTBX black plywood, stained and engraved, thickness 15 mm. To be installed on the wire cable. Supplied with assembly accessories. Dimensions change regarding the shape. Wire spacing: 40 cm.

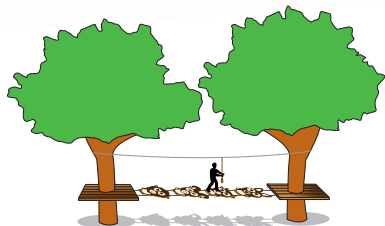

Level of difficulty

The tools of the farmer

Made of Okoume wood, thickness 40 mm, stained. Supplied with assembly accessories. Dimensions: about 75 cm x 96 cm.

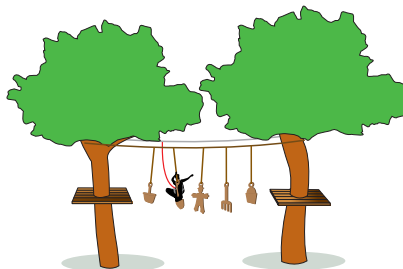

Different shapes:
scarecrow
pitchfork, basket,
shovel, bucket.



Level of difficulty

Animal metronome

Animals made of CTBX plywood, thickness 15 mm, engraved and stained. To be mounted on swing wood rafter. To be assembled on 2 bottom cables. Everything is supplied to mount the element yourself.

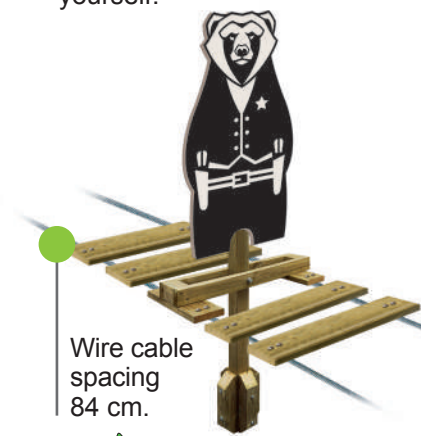

Wire cable spacing
84 cm.

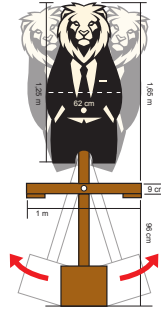

Supplied
with fixing
accessories.

Different models:
bear, panda and lion.

Different colors:



Level of difficulty

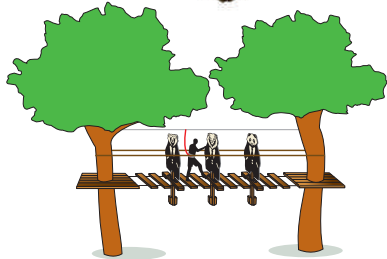

The Brick

Okoume wood, core made of popular covered with exterior wooden painting. To be fixed on 2 parallel cables. Assembly accessories included.

4 different models.
4 colors : blue, red,
yellow and green.

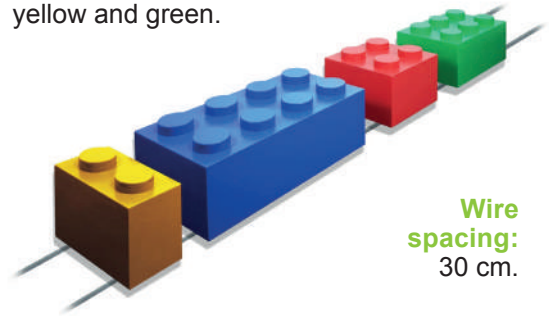

Wire
spacing:
30 cm.

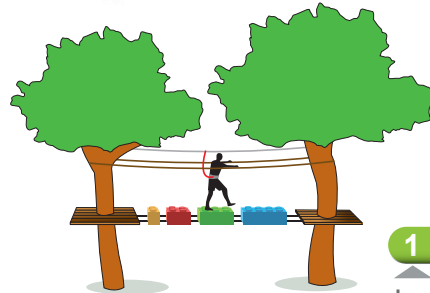

Level of difficulty

Savanna crossing

Island made of Okoumé, thickness: 18 mm, Ø of the plank : 500 mm. Supplied with assembly accessories. Recto/verso printing available as option.

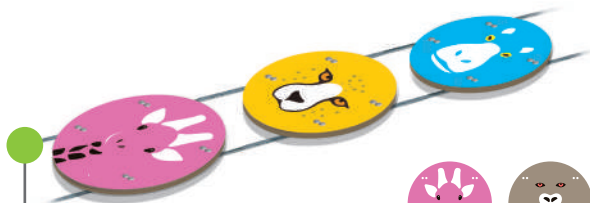

Wire cable spacing 30 cm.

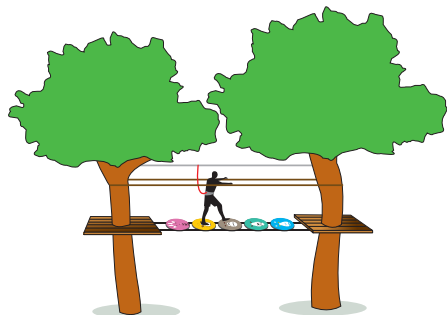

Level of difficulty

Little monsters

Island made of Okoumé, thickness: 18 mm. Dimensions: 1,02 m x 0,95 m. Recto/verso printing available as option.



Wire spacing 30 cm.

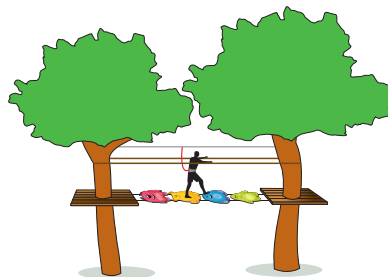

Supplied with fixing accessories.



Level of difficulty

Flowers' path

Made of colored CTBX plywood, thickness 15 mm, engraved and stained. Dimensions: 0,50 m x 0,50 m. Supplied with assembly accessories.



Wire cable spacing 30 cm.

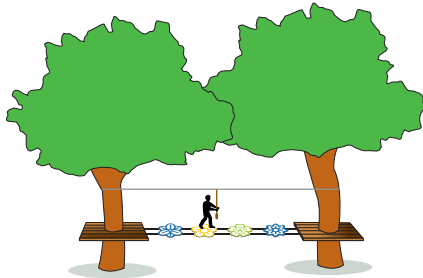

Leaves path

Non-slip CTBX exterior plywood (yellow and green) engraved and stained thickness 15 mm. To be installed on 2 parallel cables and supplied with assembly accessories. Dimensions : 50 cm x 60 cm.



Wire cable spacing 30 cm.

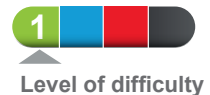
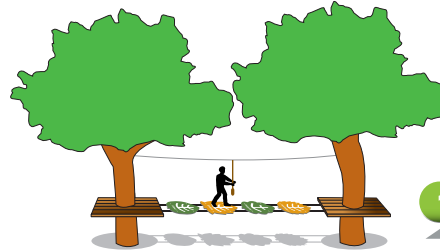

Hopscotch

Made of 10 elements of non-slip exterior plywood, 15 mm thick engraved and stained. Supplied with assembly accessories.

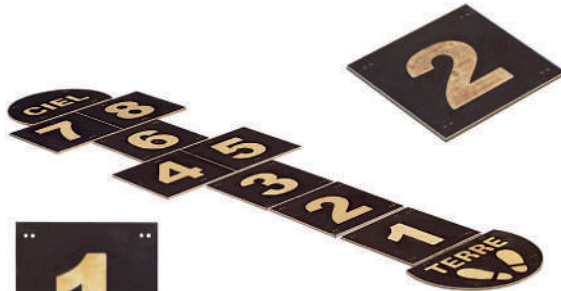

The crossing of the Knights

Shields are made of class 3 Okoumé plywood. To be fixed on 2 cables. Board supplied with fixing accessories.

Width: 58 cm.

Length: 66 cm.

Thickness : 18 mm.



Wire spacing
40 cm.



Supplied with fixing accessories.

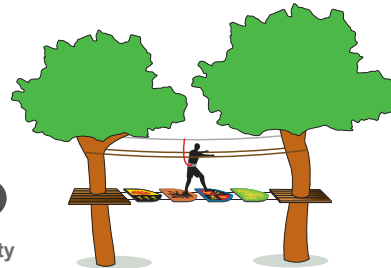

Moving and steady suspension ropes

Suspension rope made of elastic rope, in a tubular sling.

Suspension rope made of polypropylene rope, in a tubular sling.



Choice of suspension ropes allows you to get:

- A double steady suspension rope.
- A moving rope on left side and a steady rope on the right side and vice versa.

The climber will discover the fun at the very last moment!!



Yo-yo

Larch Yo-yo class 3, with a \varnothing 30 mm PP or textured PP suspension rope, with thermo sheath, thimble loop and fixing ring at the top.



Length
suspension
ropes:
1 m ■ 2 m
2,50 m.

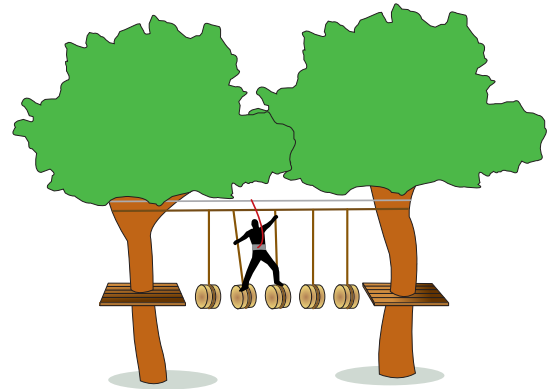

Yo-yo
dimensions:
26 cm x \varnothing 30 cm.



Level of difficulty

Spinning-top

Larch spinning top, class 3, suspended from a Ø 16 mm reinforced rope, with thimble and ring at the top.



Length
suspension
ropes:
1 m ■ 2 m
2,50 m.

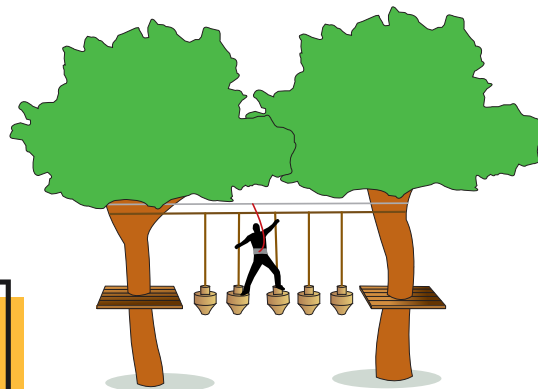

Top dimensions:
37 cm x Ø 32 cm.



Rope
colours



Level of difficulty

The little ball

Class 3 larch sphere, with painted cat's eye, suspended from a reinforced rope Ø 16 mm, with thimble and fixing ring at the top. Paint available on request: blue, yellow, red or green.

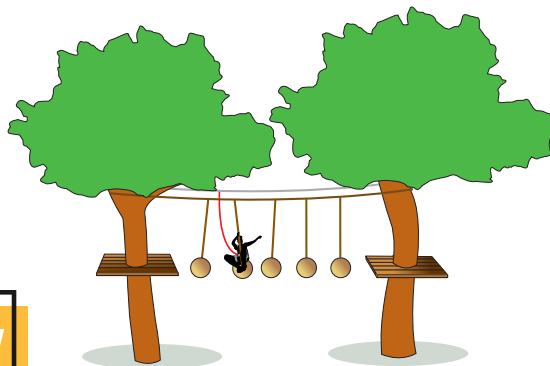

Length
suspension
ropes:
1 m ■ 2 m
2,50 m.

Diameter:
30 cm.



Rope
colour



Level of difficulty

Brazilian ladder

Ladder with aluminium rungs held in place by two Ø 16 mm reinforced ropes with thimbles and fixing ring at each end. Swivels at the ends for rotation of the ladder.



Length of rungs variable: from 30 to 45 cm.

Ladder length: 2 m.

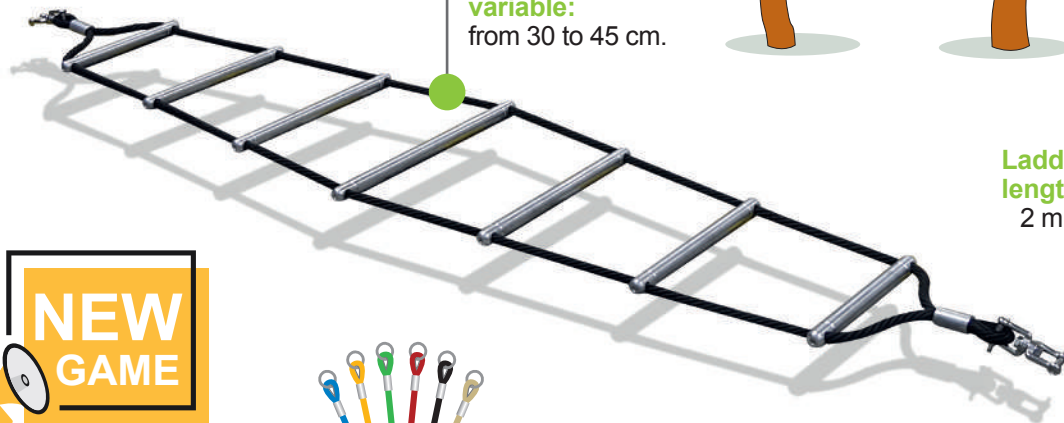

Rope colour



Level of difficulty

The Armed Stairs

Made of Ø 16 mm armed rope, crimped with a thimble and fixing ring. Equipped with a handrail and steps in autoclave class 4 wood. Module length 2 m overall, greatest height 3 m. Sold by the linear meter.

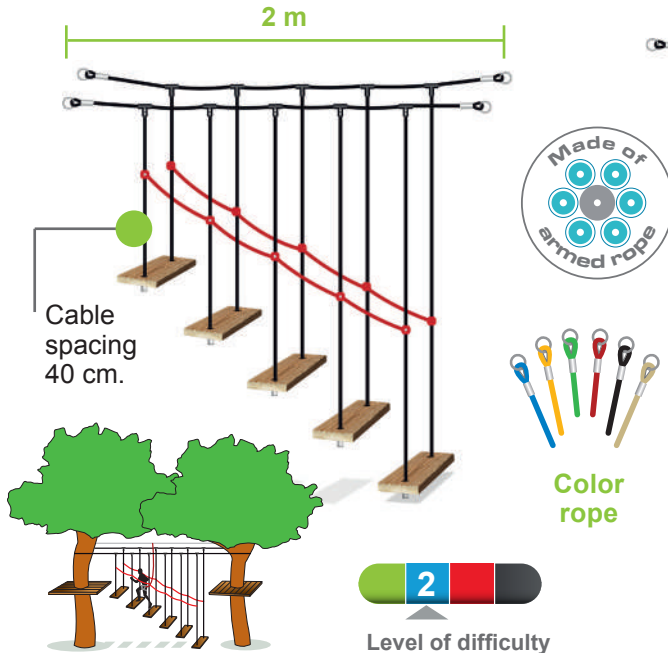

The Split

Made of Ø 16 mm armed rope, crimped with a thimble and fixing ring. Equipped with a handrail at mid-height and three autoclave class 4 wood turning logs. Length 2 m - 4 m - 6 m.

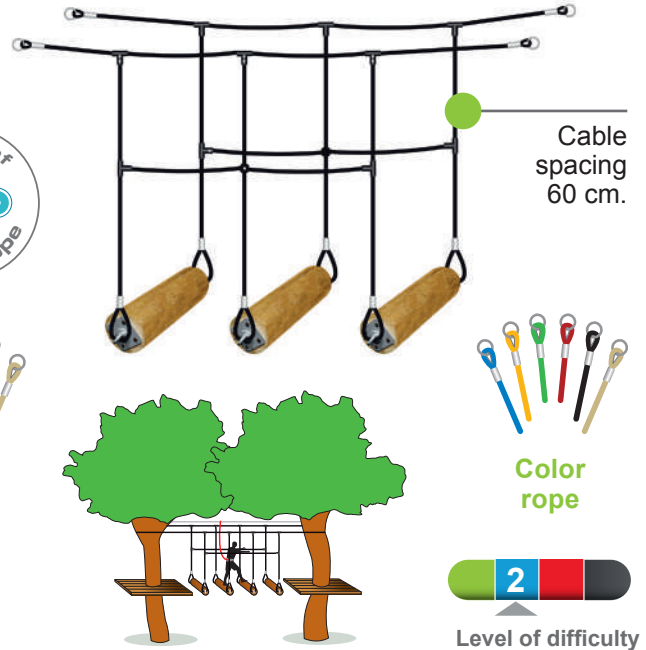

Armed steps

Made of Ø 16 mm armed rope, crimped with thimble and fixing ring. Equipped with autoclave class 4 wood steps arranged in staggered rows. Steps spacing: 50 cm. Sell to linear meter.

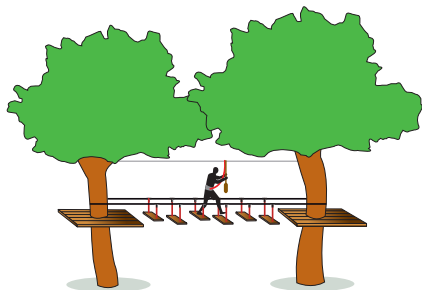
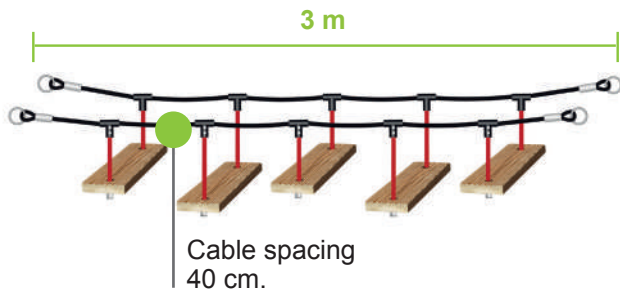

Color rope



Level of difficulty

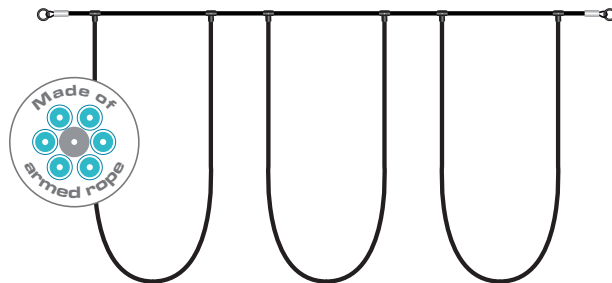

The Path of 3 Ropes

In "U" shape, installed in single file with 30 cm between each "U". The first and last rope are installed at 50 cm from the start and 50 cm from the end. It is made of Ø 16 mm armed rope. Spacing 80 cm.

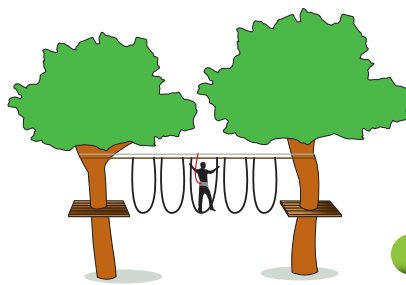

Level of difficulty

The armed rope chimney

Made of Ø 16 mm armed rope, 250 mm mesh, crimped with a thimble and fixing ring. The chimney is equipped with landings and half-landings in black, yellow, green, blue or red non-slip exterior plywood.

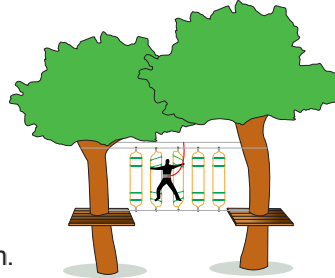
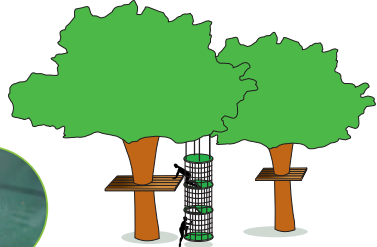
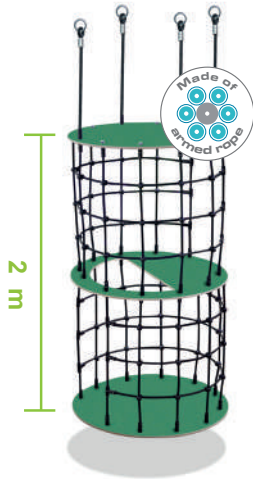

Length
3 m / 4 m / 5 m / 6 m.

Interior diameter
1 m.

1
Level of difficulty

Rotating Ladder

Made of Ø 16 mm armed rope, crimped with thimble and 360° swivel hook. Equipped with green plastic rungs. Total height: 240 cm. Spacing: 40 cm.

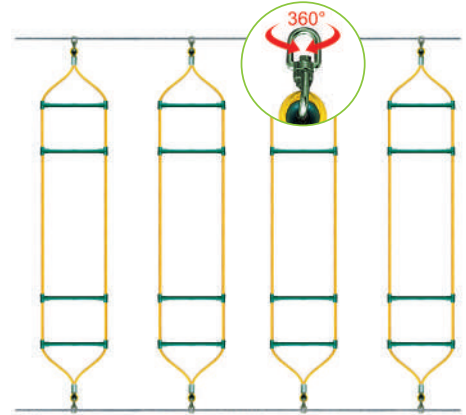

Color rope



3
Level of difficulty

The rope with brackets

Made of Ø 16 mm armed rope, crimped with a thimble and a fixing ring at the top. Yellow brackets Ø 80 mm arranged at regular intervals along the length of the rope.



Color rope

Length
3 m / 4 m / 5 m / 6 m.

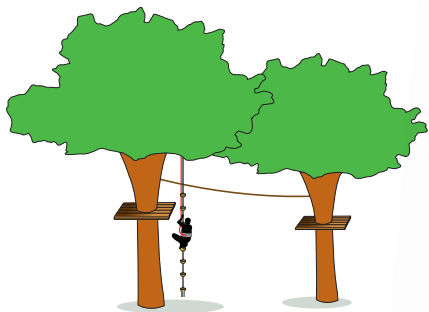

Level of difficulty



The armed hand rope

Made of Ø 16 mm armed rope, crimped with a thimble and a fixing ring at the top, cut at the bottom with a heat-shrink cap.

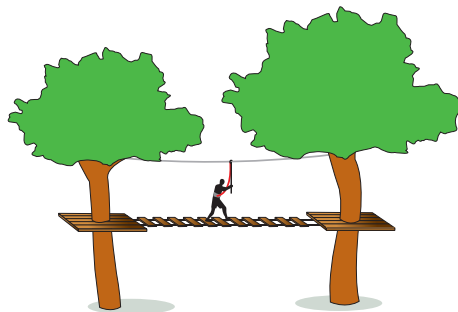

Length
1 m - 2 m - 2,50 m.



Color rope



Level of difficulty

The sun

Circle Ø 1 m, equipped with 6 armed ropes Ø 16 mm. The ropes are crimped at each end and are equipped with a thimble and a suspension ring.

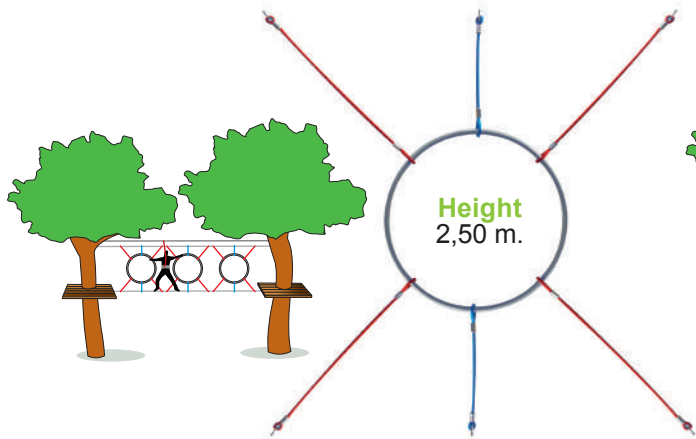

The circle and its ropes are fixed between upper and lower cables.



Color rope



Level of difficulty

Climbing ring

Armed rope Ø 16 mm crimped at one end, with a thimble and a suspension ring. Equipped with yellow gym rings.

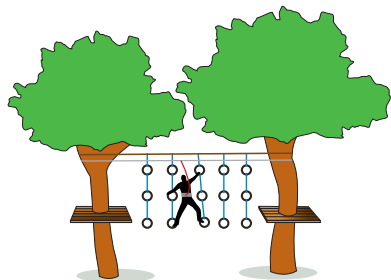

Color rope

Length 2,50 m.

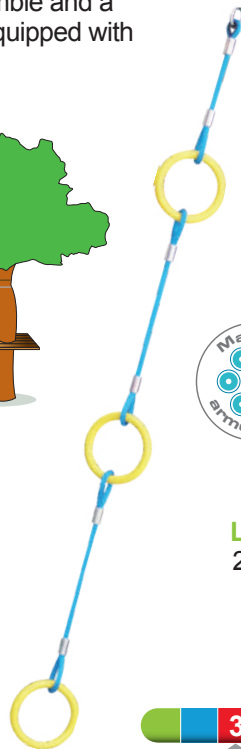

Level of difficulty

The star

Obstacle made of armed rope \varnothing 16 mm equipped with thimble and suspension ring with a central part made of grooved non-slip exterior plywood. Color red.

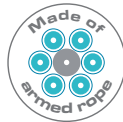
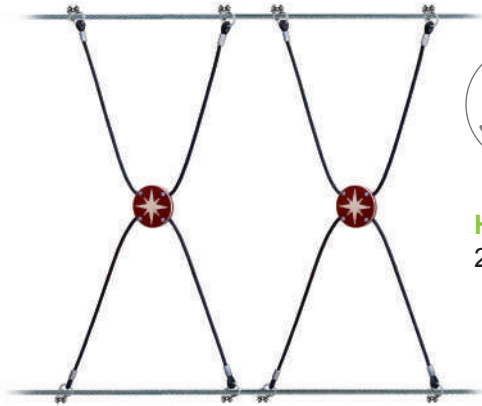

Height:
2,50 m.

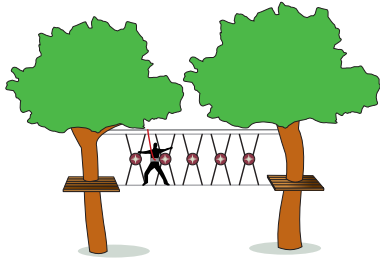

Color
rope



Level of difficulty

Zig Zag bridge

Made of grooved planks. Thickness: 36 mm equipped with armed ropes \varnothing 16 mm crimped with thimble eye and suspension ring.

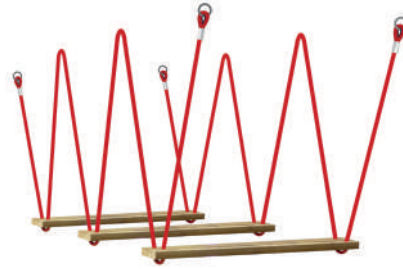

Suspension
rope
1 m.



Bridge width: 0,80 m.
Bridge length: 1,50 m.

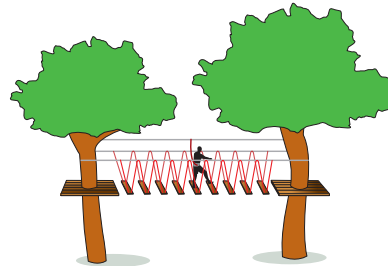

Color
rope



Level of difficulty

The snake pole

Square wood rafter 90 x 90 mm equipped with an armed rope Ø 16 mm for the feet at the bottom.

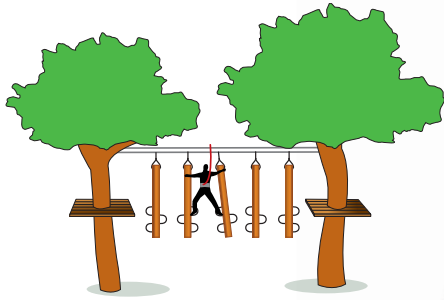

Length: 2,50 m.



Level of difficulty



Rope Ladder

Armed rope Ø 16 mm equipped with reinforced PP rungs. The rope is crimped at each end and is equipped with a reinforced loop and a suspension ring.

Width: 400 mm.



Color rope

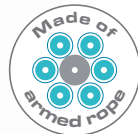
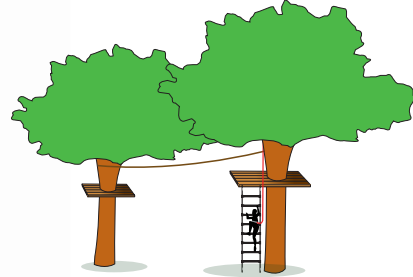

Level of difficulty

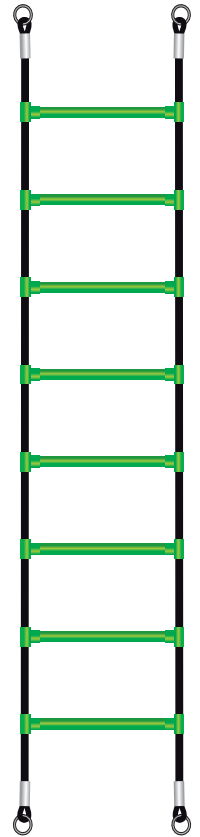

Caving ladder

Ladder with 28 aluminium rungs, held in place by two \varnothing 16 mm armed crimped ropes, with thimble and fixing ring at each end.

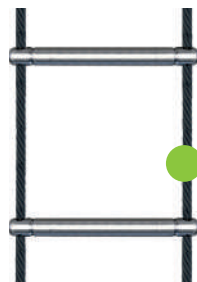

Rope
spacing
30 cm.



Color
rope

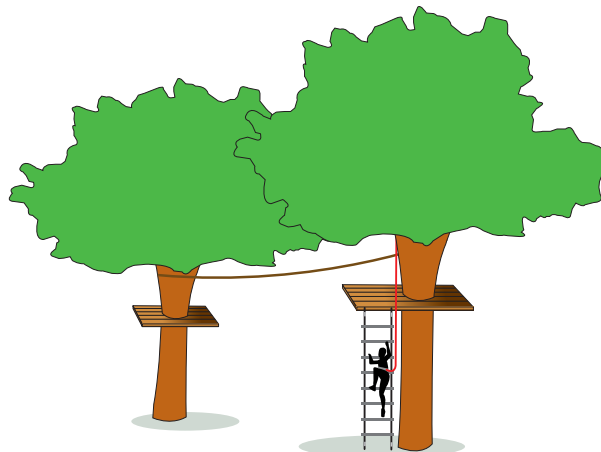
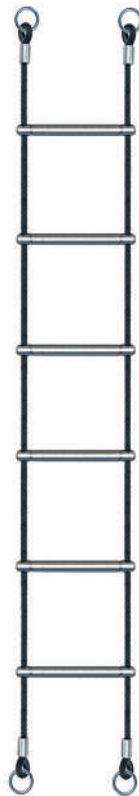

Length: 4 m et 6 m,
other dimensions
on request.



Level of difficulty

Himalayan bridge

Made of Ø 16 mm crimped armed rope with thimbles and suspension rings, reinforced PP rungs. Equipped with a high and a low handrail.

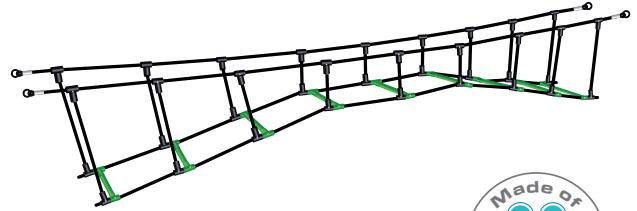
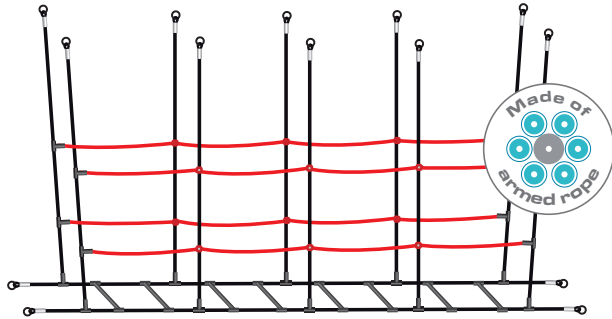

The Hand Ladder

Made of armed rope with a convex path. Green bar spaced of 40 cm from each other. Made of Ø 16 mm armed rope. Length: 4 m (effective length: 3 m).

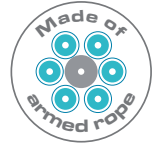

Wire cable spacing
0,40 m.



Suspension height
2,50 m.



Width
400 mm.

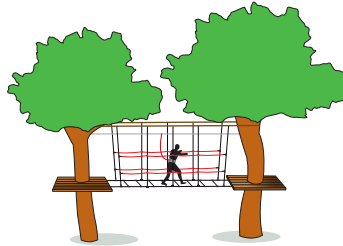

Level of difficulty

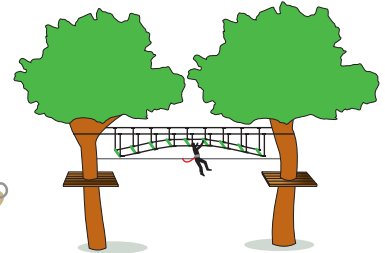

Color rope



Level of difficulty



The loop

Armed rope Ø 16 mm crimped at one end, with a thimble and a suspension ring. Provided with a Ø 16 mm rope stirrup in the lower part.

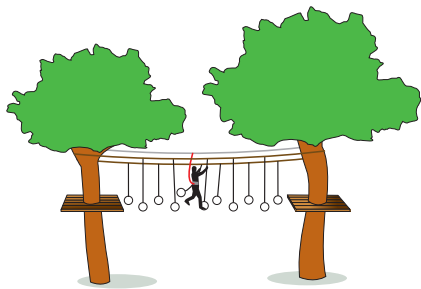

Length: 2,50 m.



Color rope

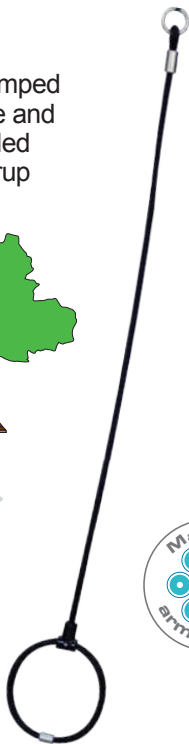

Level of difficulty

TWIRL

Hand rope

Armed rope Ø 16 mm.

- Equipped with a swivel hook.
- Suspension ring.
- Plastic handle.

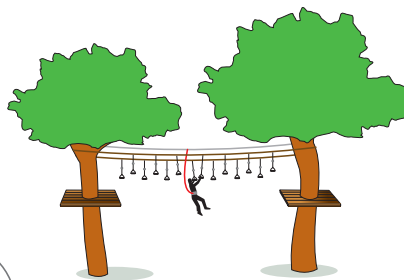

Color rope

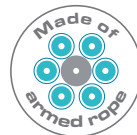

360° rotation



Level of difficulty



Rope bridge

Armed rope Ø 16 mm crimped at each end. Equipped with a thimble and a suspension ring.



Width: 560 mm.

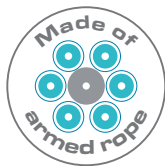

Color rope



Level of difficulty

U-form rope

Armed rope Ø 16 mm crimped at one end, with a thimble and a suspension ring.

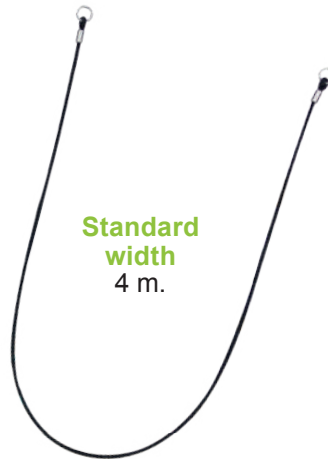

Standard width
4 m.

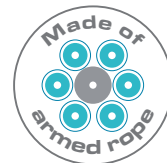

Color rope

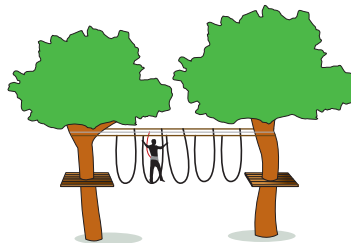

Level of difficulty

Suspended banana

Banana-shaped foam covered with yellow PVC sheeting, fitted with 4 suspension ropes sewn onto a ring.

Total foam length:
150 cm x 47 cm.



Length at ends:
31 cm x 35 cm.

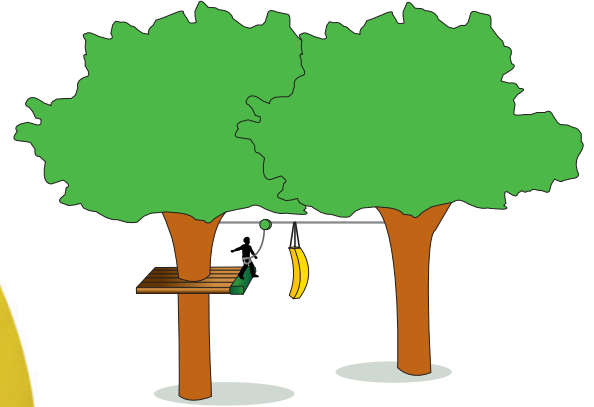

Level of difficulty

Coco Monkey

Polypropylene Monkey fist ball Ø 300 mm, equipped with a suspension rope Ø 20 mm with thimble and suspension ring at the top.

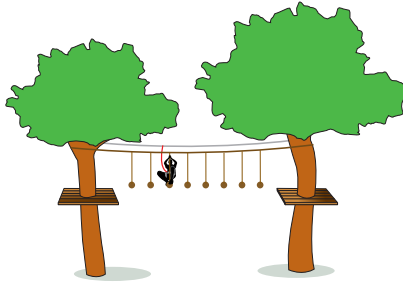

Level of difficulty 4

Pyramid

Composed of:

- 1 wood base treated autoclave class 4.
- 4 reinforced aluminum bars Ø 30 mm.
- Exotic wood head.
- Brake nut Ø 24 mm.
- Armed suspension rope Ø 16 mm crimped at each end with a thimble and a suspension ring.

Dimension of the base 80 cm x 80 cm.

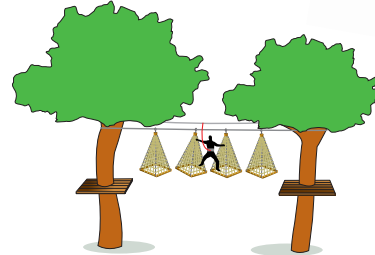

Level of difficulty 3

The Step

“Polyform” boat fender equipped with a suspension rope Ø 20 mm with thimble eye and suspension ring.

Length 2,50 m.

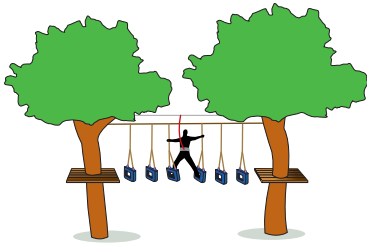

The Swing of the Captain

“Polyform” boat fender in arch shape equipped with 2 suspension ropes Ø 20 mm with thimble eye and suspension ring.

Color of the suspension rope
green, beige, havana,
black, blue and yellow.

Length of the suspension rope
2,50 m.

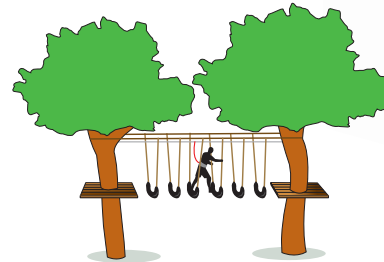

Cocoon

PVC Ball Ø 60 cm covered with a polyamide mass-colored net, braid 5 mm and mesh 25 mm. Color green.



Other use
Game for zip-line

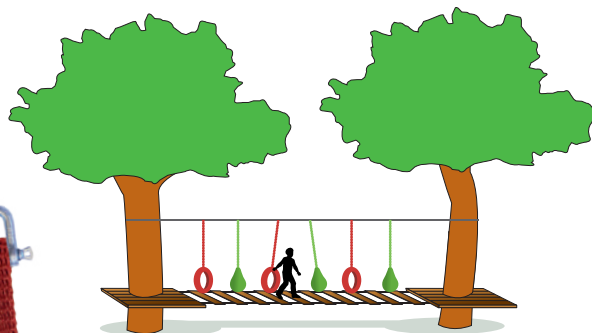

Donuts

Rubber tyre Ø 55 cm covered with a polyamide mass-colored net, braid 5 mm and mesh 25 mm. Color red.



Level of difficulty

Color Bag

Sack made of rope Ø 16 mm. Diamond mesh: 150 mm.
Sack Ø 600 mm, height 2,40 m equipped with 2 suspension ropes with thimble. Filled with colored foam cubes.



Colored foam cubes or peanut balls sold separately.

Wrecking Ball

Sack Ø 600 mm.
Height 1,20 m.
Rope Ø 16 mm.
Diamond meshes 150 mm.
PVC Ball Ø 600 mm.
Equipped with 2 suspension ropes with thimble.

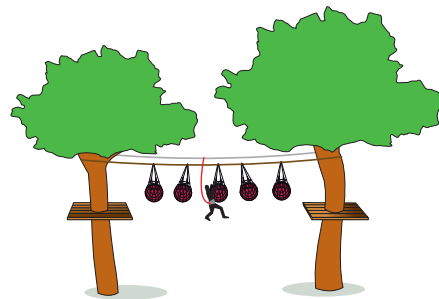

Level of difficulty

Pirate swing

PP rope (140 x 140 mm) equipped with reinforced suspension rope (Ø 16 mm). Available in 3 lengths: 1,35 m, 1,85 m and 2,35 m. Suspension ropes have a V form.



Stainless quick links
M6 large opening
with large opening.



Level of difficulty

Fisherman bridge

Rope Ø 100 mm, in textured polypropylene provided with 2 different lengths of suspension ropes fixed every 1,50 m.

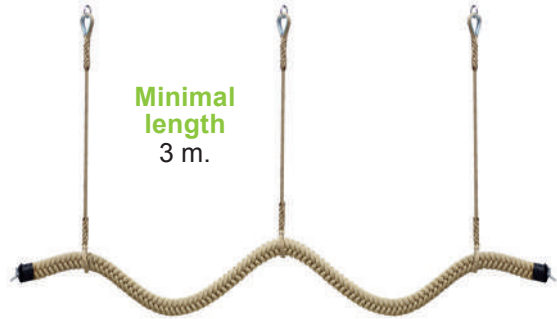

Minimal
length
3 m.

- Child course: suspension ropes 1,50 m and 1,80 m.
- Adult course: suspension ropes 2,50 m and 2,80 m.

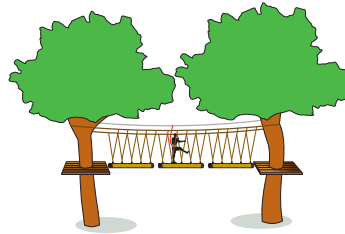

Level of difficulty

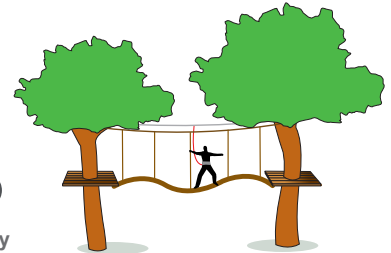

Coconut swing

Braided Polypropylene swing length 60 cm equipped with two polypropylene suspension ropes \varnothing 20 mm with thimble and suspension ring. Length rope: 2,50 m.

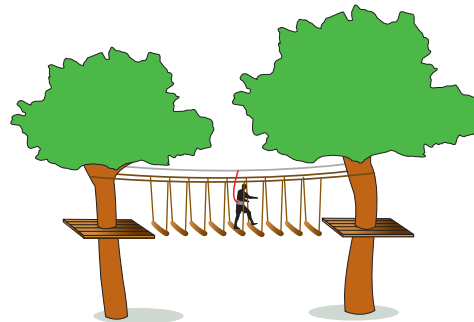

Level of difficulty

The Tyre

Made of molded black polypropylene, equipped with 2 suspension ropes \varnothing 16 mm with thimble eye and suspension ring.

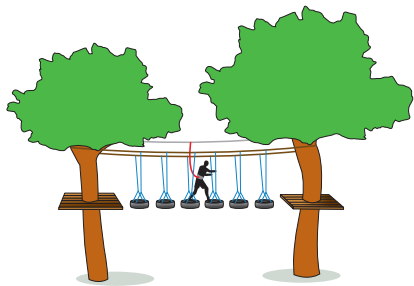

Length: 2,50 m.

Color of the suspension ropes
green, beige, havana, black, blue or yellow.



Level of difficulty

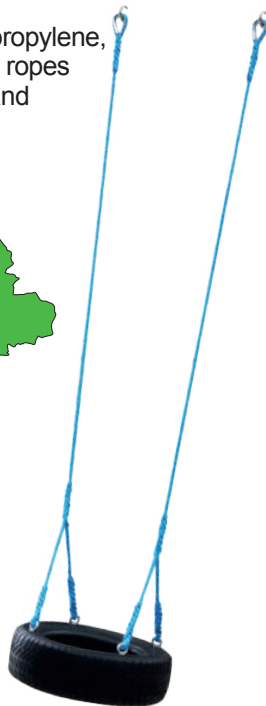

Climbing wall

Climbing wall made with planks class 4 and provided with inserts and with a set of climbing holds.

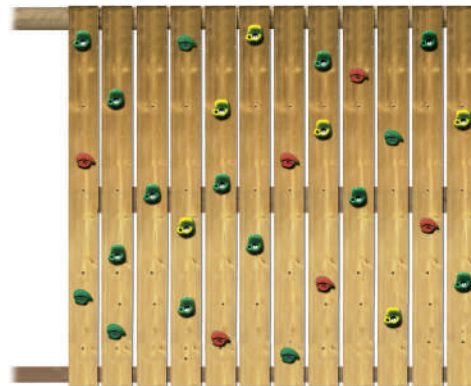

Module dimensions
2 m x 3 m.

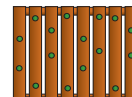

Possibility to connect them with a connecting part.



Level of difficulty



Climbing fresco

Wall planks made of Okoumé wood, thickness 18 mm, dimensions: 1,22 m x 2,00 m. Wood printing. Supplied with a bundle of 30 climbing holds* and accessories. Option: customizable theme.

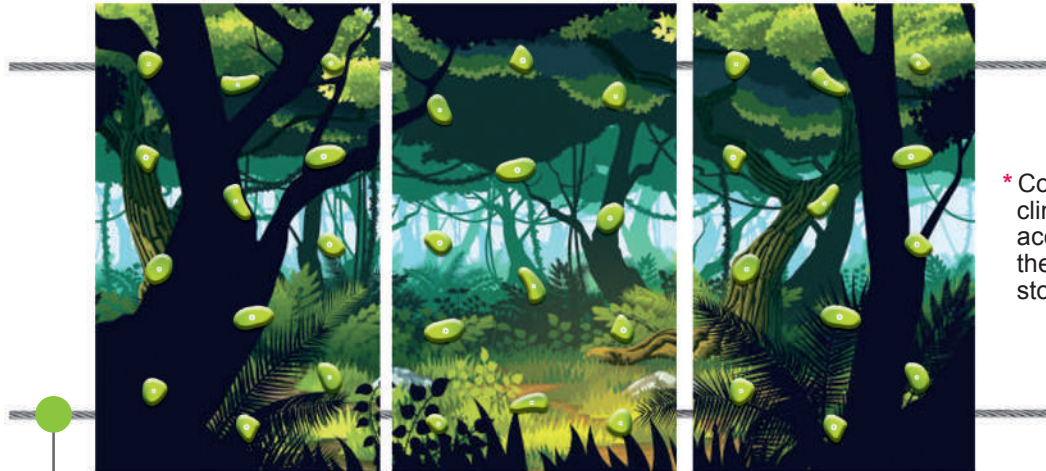

Wire cable
spacing 1,80 m.

Nature

* Colors of the climbing holds according to the available stock available.

Pop



Street'art



Chinese



Chinese

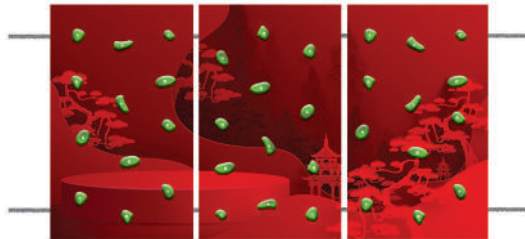

Enchanted climbing wall

Wood structure, height 2 m, to fix on a hig-cable and on a low-cable.
2 plywood boards: one above and one below. Both are equipped with holds. Assembly accessories included.

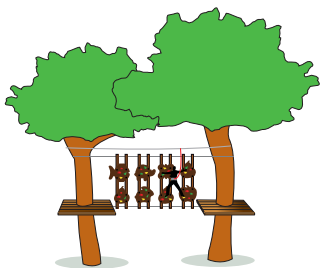

1 - Hand and foot holds.

Climbing holds*

* Socket colors according to available stock.

2 - Plank

Available colors red, yellow, blue or black.



Level of difficulty

Zebulon

Anti-slip disc Ø 300 mm mounted on a red spring. Spring is fixed to a floor Ø 600 mm.

Comes with assembly tools.

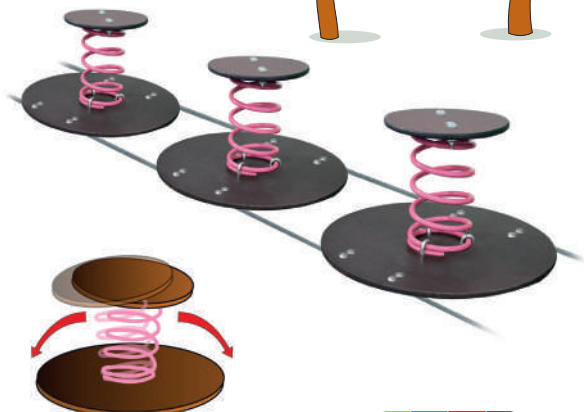
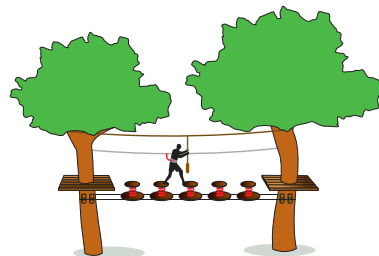

Moving disc



Level of difficulty

Jungle wall

Animals made of non-slip exterior plywood, thickness 15 mm, engraved and stained, to be fixed on 1 upper and 1 bottom cable. Dimensions: 1,22 m x 2 m. Form : Panda, Bear or Gorilla, to be specified. Supplied with assembly accessories.

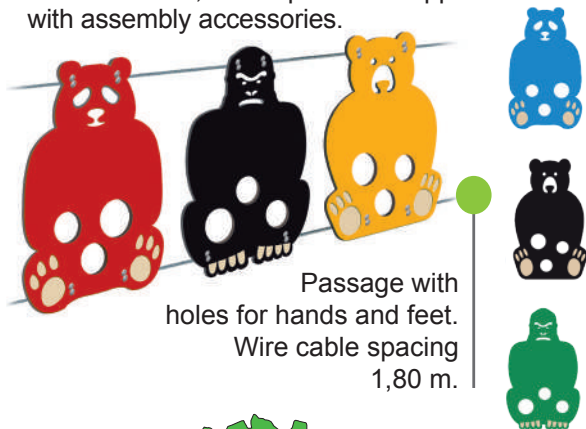

Passage with holes for hands and feet.
Wire cable spacing 1,80 m.

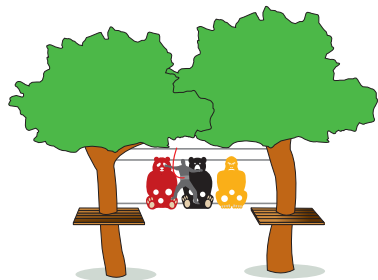

Colors: blue, yellow, green, red or black.



Level of difficulty

Ghosts

Suspended wood ghost head. Equipped with 2 galvanized chains. Plywood thickness: 15 mm.



Colors black, yellow, green, blue or red.



Option

Galvanized chain to attach the different modules together, supplied with quick links.

Length: 1 m.

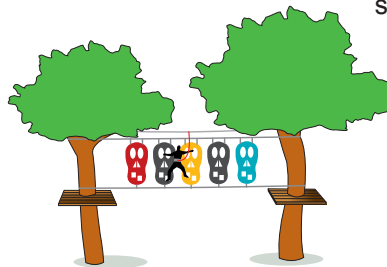

Level of difficulty

Commando net

Net made of 35 mm polyester straps, 150 mm mesh. Equipped with suspension rings every meter. It can be used either as a climbing net or walking net.

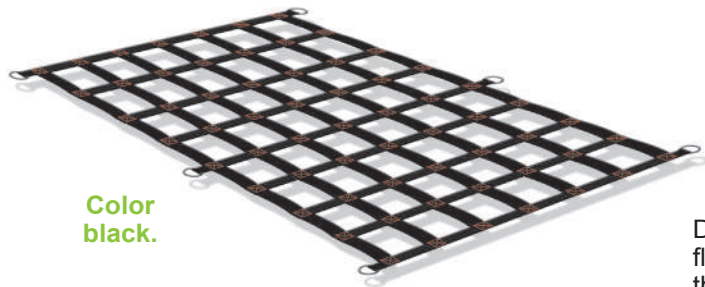

Color black.



Level of difficulty

The cradle

Net tunnel, mesh 50 mm, mounted on a tubular steel structure.

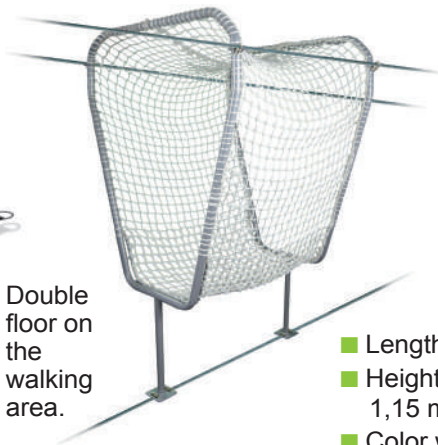

Double floor on the walking area.

To fix on 2 high cables and 1 low cable.

- Length: 1 m.
- Height net: 1,15 m.
- Color white.

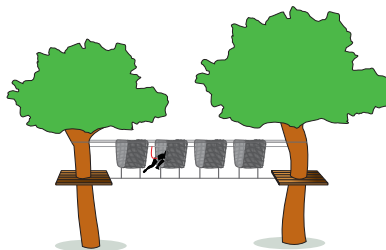

Possibility of use on Chinese bridge.



Level of difficulty

Infernal roll

Roll made of polyethylene high resistance equipped with protection mattress, thickness: 20 cm with suspension ring. Color: red.

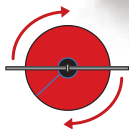
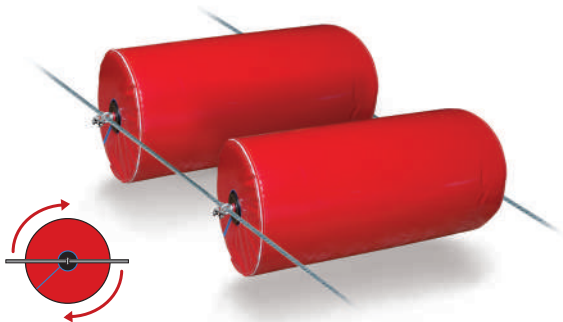

360° rotation

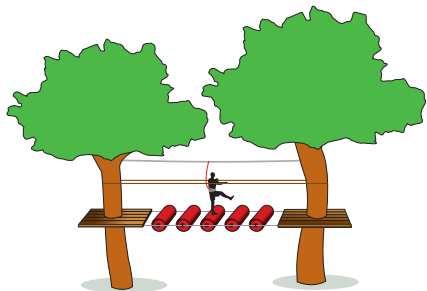

Length:
1,11 m.
Diameter:
0,53 m.
Cable spacing:
1,20 m.



Level of difficulty

Speed wheel

Cleaned tyre equipped with 2 discs made of red grooved non-slip exterior plywood mounted on a rotating axis. To be on 2 wire cables.



360° rotation

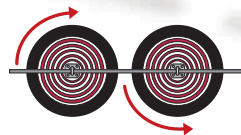

Ø 60 cm.

Cable spacing:
22 cm.

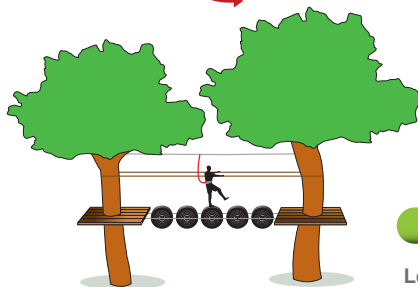

Level of difficulty

The Basin

Genuine wooden basin mounted on 2 connector boards equipped with a rotation axis. Fix on two support cables.



Dimensions

Basin height: 35 cm.
Basin length: 66 cm.
Cable spacing: 72 cm.

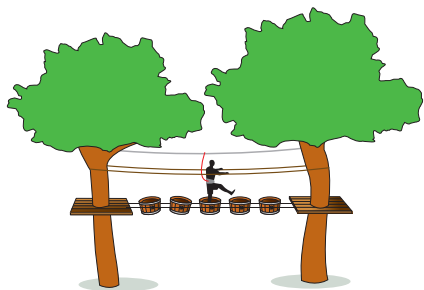

Wine-Grower Passage

Genuine wooden barrel mounted on 2 connector boards equipped with a rotation axis. Fixed on two support cables.



Dimensions

Barrel height: 66 cm.
Barrel length: 95 cm.
Cable spacing: 100 cm.

Possible use
as a horizontal
game module.

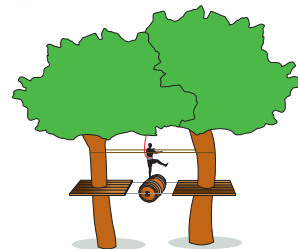

The Gallic challenge

Genuine wooden barrel mounted on 2 connector boards equipped with an rotation axis.

- Dimension: Ø 32 cm.
- Height: 44 cm.

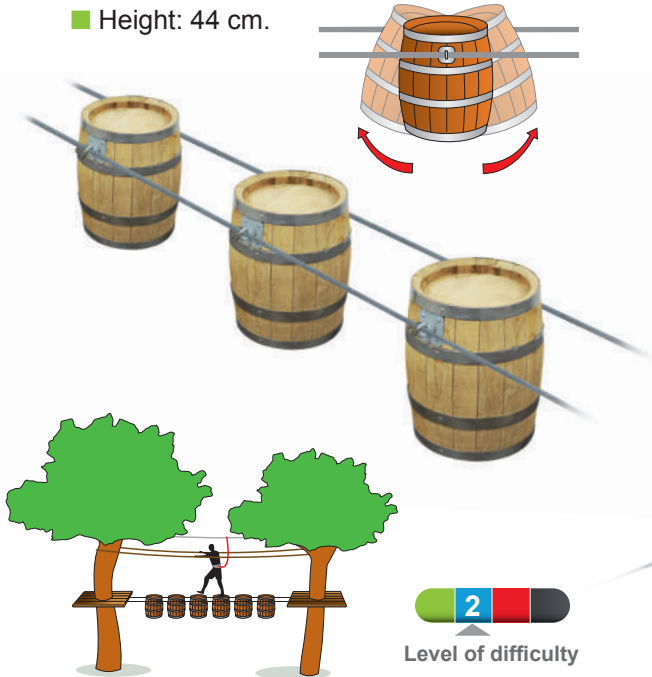

Spider Box

Wooden box autoclave class 4, fixed on a non-slip floor. Dimensions: length 0,80 m, width 0,60 m, height 0,62 m.

This box is supplied with assembly accessories and sandow, allowing you to create and customize your game module.

Sandow Ø 9 mm
20 m. Color black.

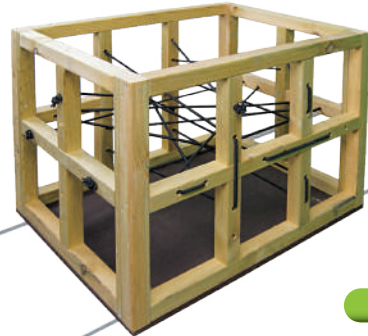
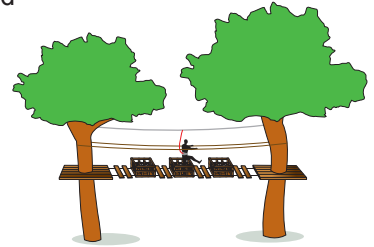

Anchor island

Made of Okoume exterior plywood, thickness 40 mm, stained. Supplied with the assembly accessories.

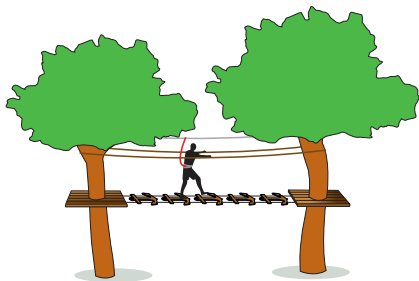
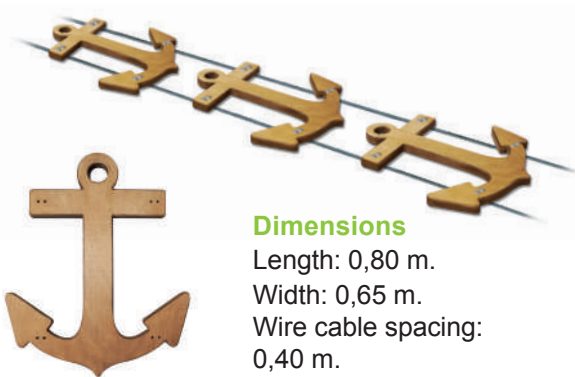

Bretzel

Made of Okoume exterior plywood, thickness 40 mm, stained. Supplied with the assembly accessories.

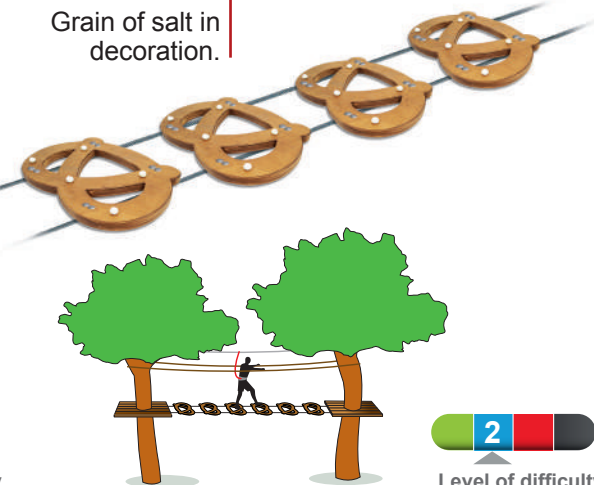
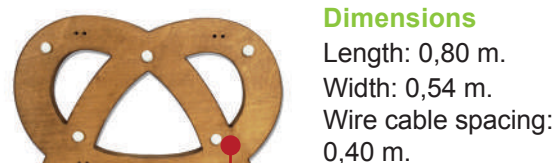

Mushroom

Solid wood mushroom, hat \varnothing 300 mm.
With mounting accessories.

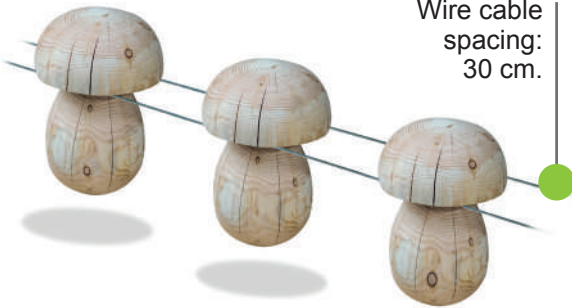

Available natural or with red paint and white stains.

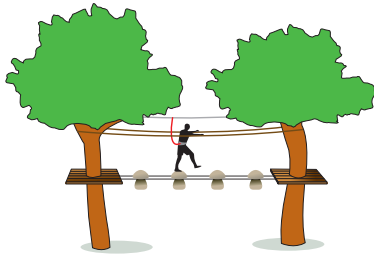

Bump

In atable 1/2 sphere. Color black. To fix on wire ropes, \varnothing 600 mm. Comes with assembly accessories.

Color: black.

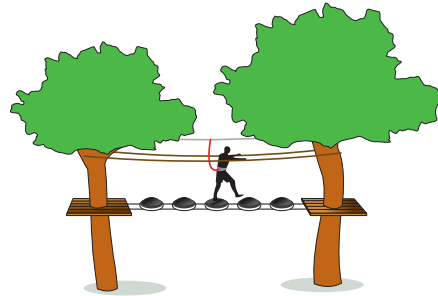

Wire cable spacing: 30 cm.



The Bunch

Colored, engraved and varnished non-slip exterior board. Supplied with assembly accessories.

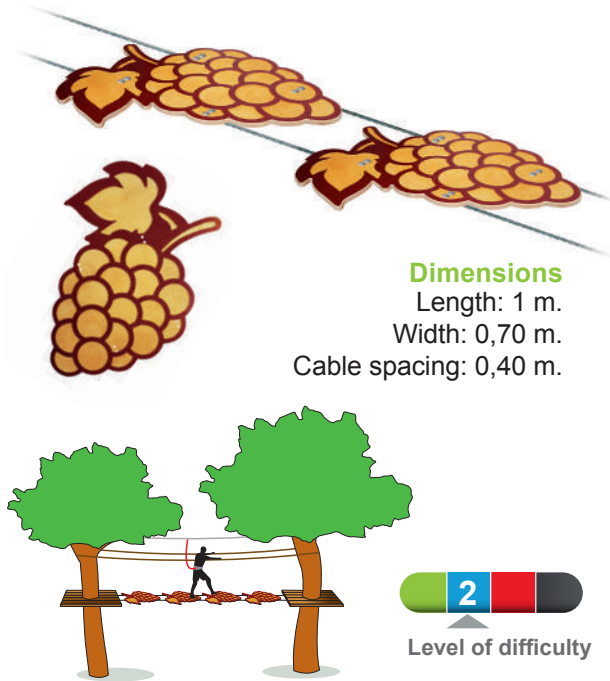

Dimensions

Length: 1 m.
Width: 0,70 m.
Cable spacing: 0,40 m.

Zoo collection

Plank made of engraved and varnished non-slip exterior plywood supplied with assembly accessories. The collection is currently composed of 8 elements: **the lion, the zebra, the elephant, the panda, the crocodile, the monkey, the rhino and the koala.**



Wire cable spacing:
0,40 m.

Walking eggs

Yellow, green, red, exterior non-slip plywood, engraved and stained. Thickness 15 mm. To be installed on 2 wire cables. Supplied with assembly accessories. Dimensions : 50 cm x 60 cm, thickness 15 mm.

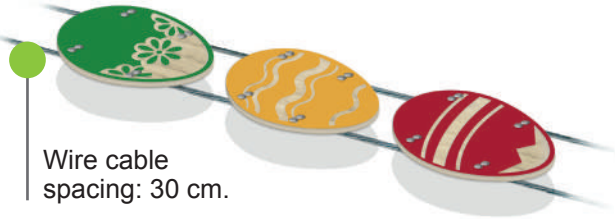

Wire cable spacing: 30 cm.

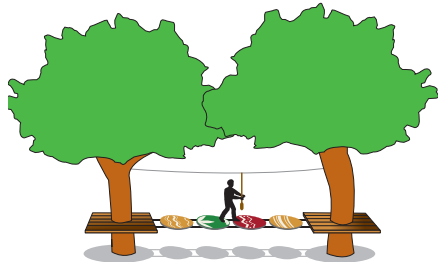

Level of difficulty

Big eggs

Yellow, green, red, exterior non-slip plywood, engraved and stained. Thickness 15 mm. Vertical fixing on 4 wire cable. Dimensions: 180 cm x 122 cm. Path: 90 cm x 75 cm.

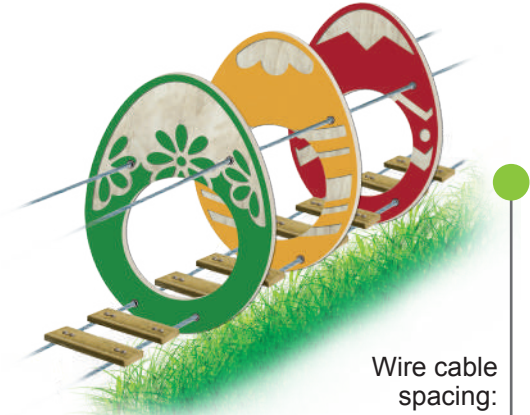

Wire cable spacing: 90 cm.

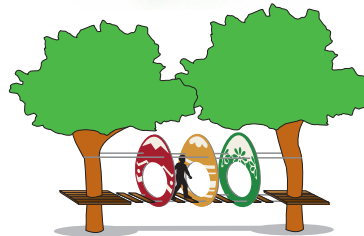

Level of difficulty

Alphabet footbridge

Customize your suspended bridge by displaying a theme, the color of your course, the name of your park, etc...

Colors yellow, red, blue or black.

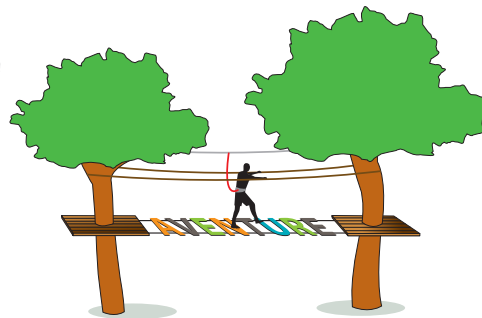

The game

SPSFILETS

The signage

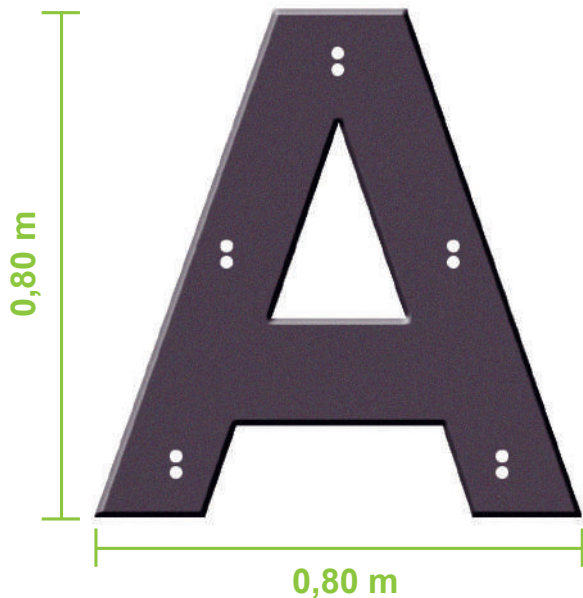

Descriptif
 Non-slip exterior plywood.
 15 mm thick.
 Supplied with assembly accessories.



Lion's head

Non-slip exterior plywood in the shape of a lion's head to be fixed on 4 wire cables. Color: red.



Height
1,95 m.

Width
1,70 m.

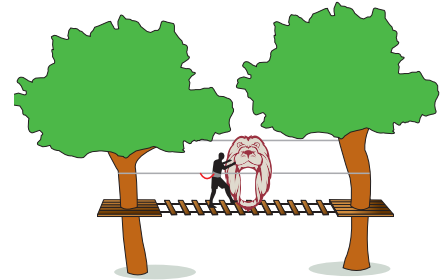

Other shapes
available on
request.



Level of difficulty

Pulley for rolling games

Pulley with a stainless steel shackle

(breaking point 2T400 coef cient 5).
Equipped with plastic wheels to prevent premature wear of the wire rope.



3 wheels

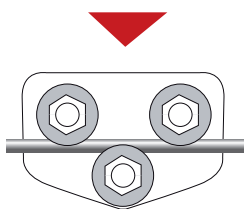

Pulley with a stainless

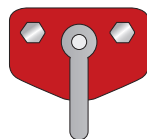

On the following pages,
the pulley suits to the
game which is displayed
on the illustrations of
courses.

Tandem Speed Petzl

It is the fastest carriage pulley. It is specifically designed for lower-angle zipline traverses.



Tandem Speed
Petzl



Zipline handle

Aluminium handles to fix on a pulley to prevent the user from twisting.



The handle is to be put on the pulley which is attached on the harness.



Light
500 gr

Equipped with
2 non slip handles

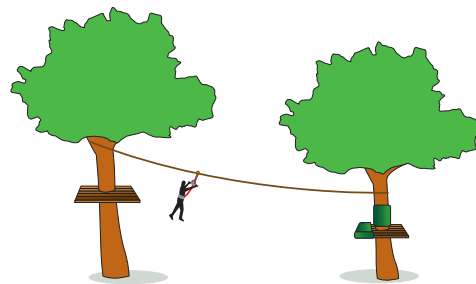

TRAC Pulley Petzl

Drop-proof unit and easy to connect.



Level of difficulty

Handle for Zipline

Plastic handle, fixed on polyester suspension rope \varnothing 16 mm.



Easy adjustment.



Level of difficulty

Spreader

Grey plastic film laminated steel beam, provided with 4 attachment for suspension ropes.



Length 1 m.

2
possible
uses

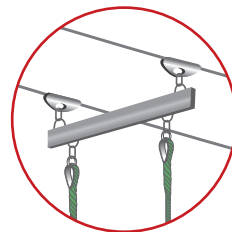
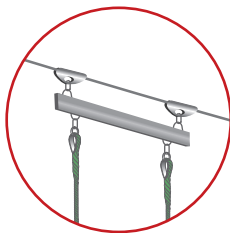

Carabiners and pulleys
sold separately.



4
carabiners



2
pulley
Tandem
speed



The pencil case

Brown PVC-coated foam case with top zip. Equipped with 2 suspension ropes PP Tex 20 mm, length 2,50 mm, color Havana brown.



Dimensions:
120 cm x Ø 50 cm.

Non contractual.

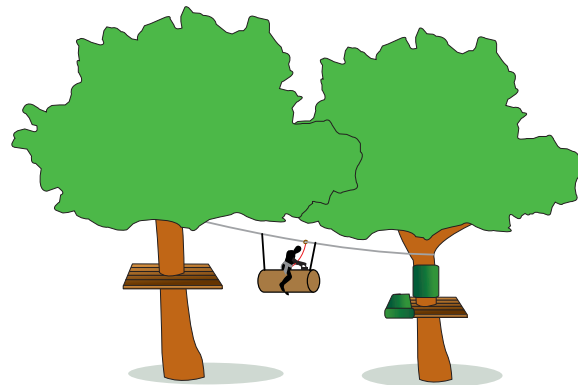

Sold separately
Pulley with shackle

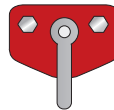

Level of difficulty

Rising zip-line

We offer you a new solution to reach the upper platform for an obstacle change. To move easily.

Composed by:

- 2 splices with thimble in a ring connected to a pulley by a swivel.
- Anti-slip seat board connected to 2 x Ø 100 mm logs treated autoclave class 4.
- Spreader log.
- Polypropylene ropes (similar to natural hemp) Ø 16 mm.
- Central splices.

Dimension ground
80 cm x 80 cm.
Height: 1,80 m.

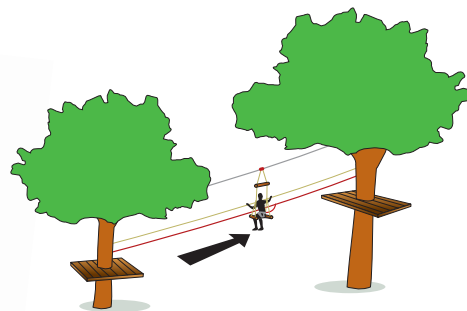

Sold separately
Pulley with shackle

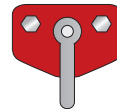

Level of difficulty

The Sphere

“Polyform” red boat fender Ø 800 mm, equipped with one suspension rope Ø 30 mm.



Length
1,50 m.



Level of difficulty

Use:
zipline game.

The hoop

Braided swing made of mass-colored polyamide consisting of a tire seat. Supplied with a straight shackle CE Ø 16 mm.

Heavy-duty suspension..
Hanging with straight shackle..

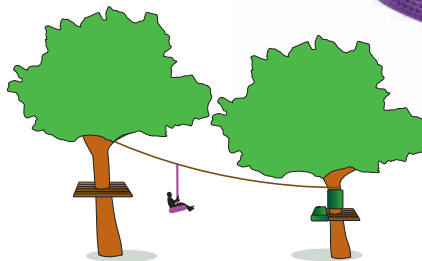

Level of difficulty

Flying anchor

Made of Okoume exterior plywood, thickness 40 mm, stained. Supplied with the assembly accessories.

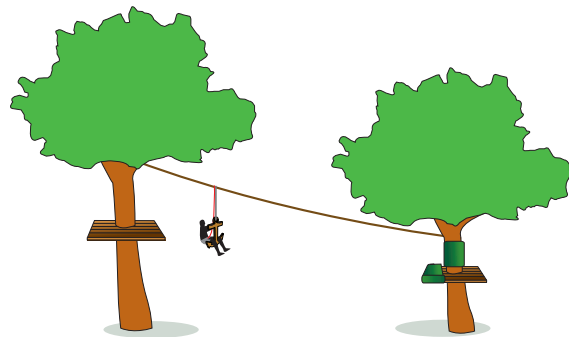

Sold separately
Pulley with shackle

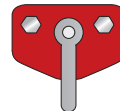

Dimensions

Length: 0,80 m.

Width: 0,65 m.



Level of difficulty

Pirate zip

Polypropylene Monkey's fist ball Ø 300 mm, equipped with a suspension rope Ø 30 mm with thimble and suspension rings.

Total length: 2,50 m.

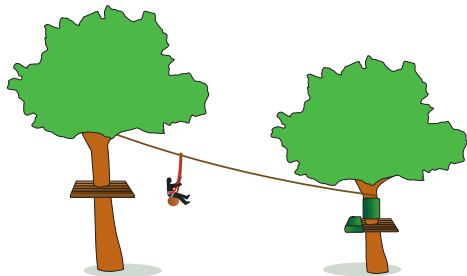

Sold separately
Tandem Speed Pulley
Petzl



Level of difficulty



Zip-line swing for kids

Galvanized steel hanging chain with a black PVC sheath.
Length 2,50 m.

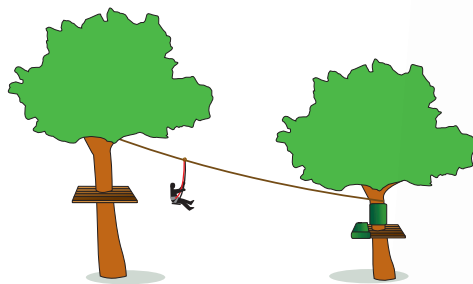

Sold separately
Tandem Speed Pulley
Petzl



Level of difficulty

Rubber disk
Ø 400 mm.



Baby Ball

Buoy (swing)

- Suspension rings and galvanized steel rings (in the shape of a 8). Adjustable polypropylene suspension rope \varnothing 12 mm from 75 cm to 1,50 m.
- Polypropylene parts, color black.
- Supplied with a valve.

Not in ated. Colors red.

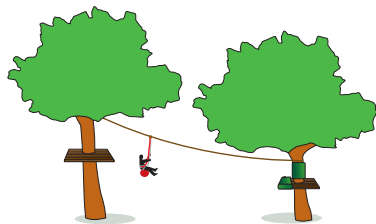

Sold separately
Tandem Speed Pulley
Petzl



Level of difficulty



The ball

Coconut fiber ball \varnothing 350 mm

- Equipped with a textured polypropylene suspension rope \varnothing 30 mm.
- Thimble and suspension ring at the top.

Rope length: 2,40 m.

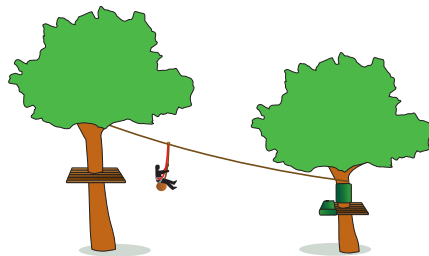

Sold separately
Tandem Speed Pulley
Petzl



Level of difficulty



Indispensables

Flying fox rope

Textured polypropylene rope Ø 30 mm.

- Rope loop 200 mm at the bottom.
- Thimble and ring suspension at the top.

Length: 1 m.

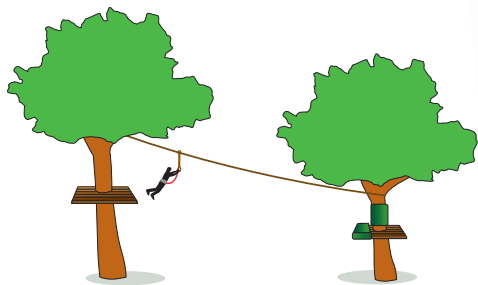

Sold separately
Tandem Speed Pulley
Petzl

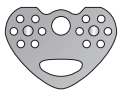

Level of difficulty

Handlebar

- Hot-dip galvanized.
- Equipped with 2 non-slip handles.
- Protective foam in the middle.



Sold separately
Tandem Speed Pulley
Petzl

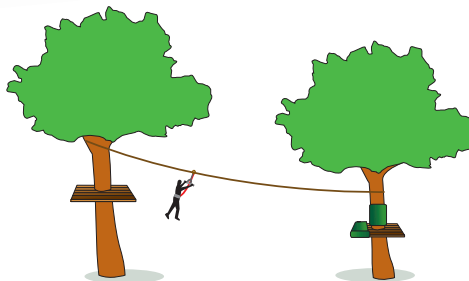

Level of difficulty

Spiderman zip line

- Shock-absorbing sheathed steel frame.
- Reinforced net cordage Ø 16 mm.
- Chain made of galvanized steel Ø 6 mm.
- Chain length 75 cm.
- Rope total length 117 cm.

Adjustable rope length.

Other use
Swing



For children and adults.

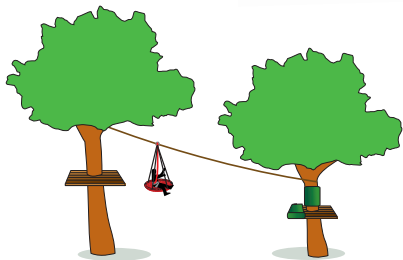

Sold separately
Tandem Speed Pulley
Petzl



Level of difficulty

Basket

Swing

- Soft ring.
- Polypropylene parts, color black.
- Suspension rings and galvanized steel rings (in the shape of a 8).
- Seated use only.

Colors
green/
black.

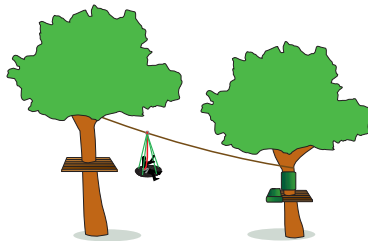
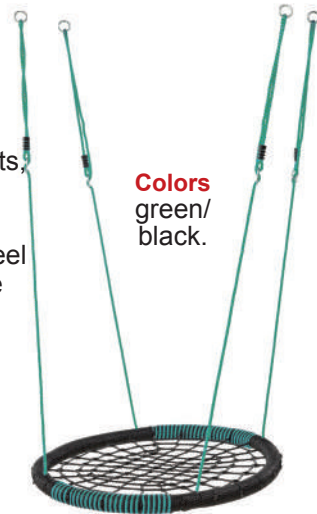

Oval
Length 1 m.
Max width
0,80 m.



Level of difficulty

The Flying Buoy

Giant inflatable buoy covered with a braided mass- tinted polyamide net equipped with 4 suspension ropes and 4 shackle Ø 16 mm CE.

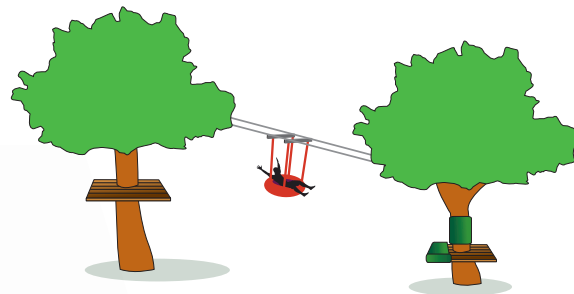

Heavy-duty mesh.



Comfortable seating.

Suspension rope's length

1,50 m.

Buoy's thickness

35 cm.

Diameter of the buoy

1,30 m.

Sold separately

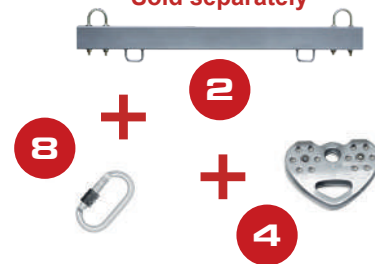

Level of difficulty

Trapeze

Wooden trapeze Ø 30 mm

Thimble and suspension rings at the top.

Equipped with 2 suspension ropes Ø 16 mm. Length 1 m.



Cable spacing
70 cm.

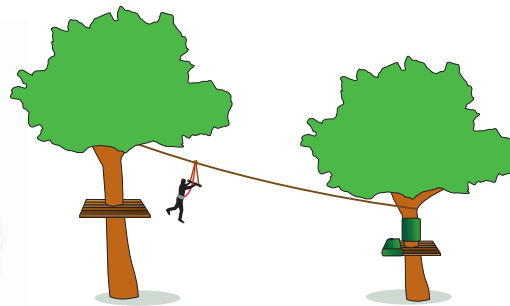

Sold separately
Tandem Speed Pulley
Petzl



Level of difficulty

Scooter Zip

Steel Kick Scooter equipped with 4 pulleys tandem speed on the floor part and one on the top part.

- Color grey.
- Adjustable. Maximum: 2,50 m.

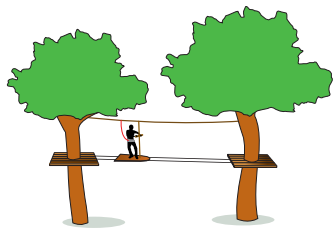

Low height course only.

2,50 m

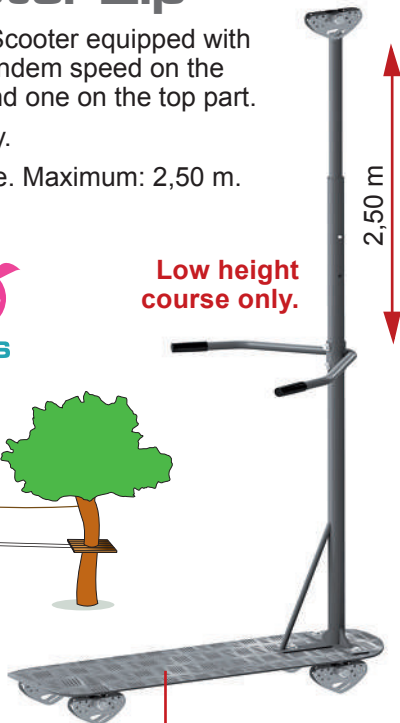

Non-slip floor



Level of difficulty

Surfboard

Oscillating on springs.

- 1 textured polypropylene suspension rope Ø 30 mm with thimble and ring and reinforced grip at the bottom.
- 1 non-slip board.
- 1 oscillating system.
- 4 pulleys Tandem Speed.

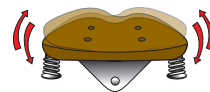
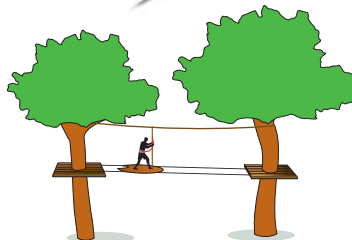

Oscillating system



Level of difficulty

Sledge

Wood sledge, mounted on a pine wood structure, maintained by threaded rods \varnothing 16 mm, protected by an aluminium sheath. Equipped with 4 Nylon pulleys wheels.

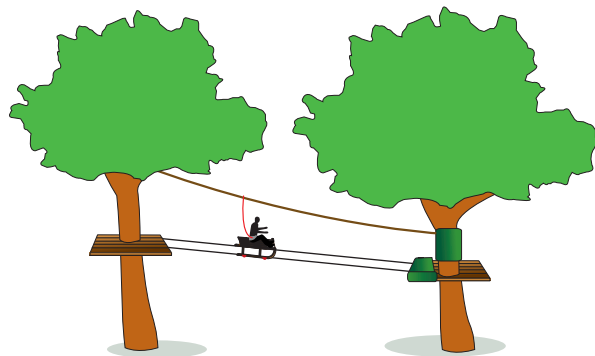
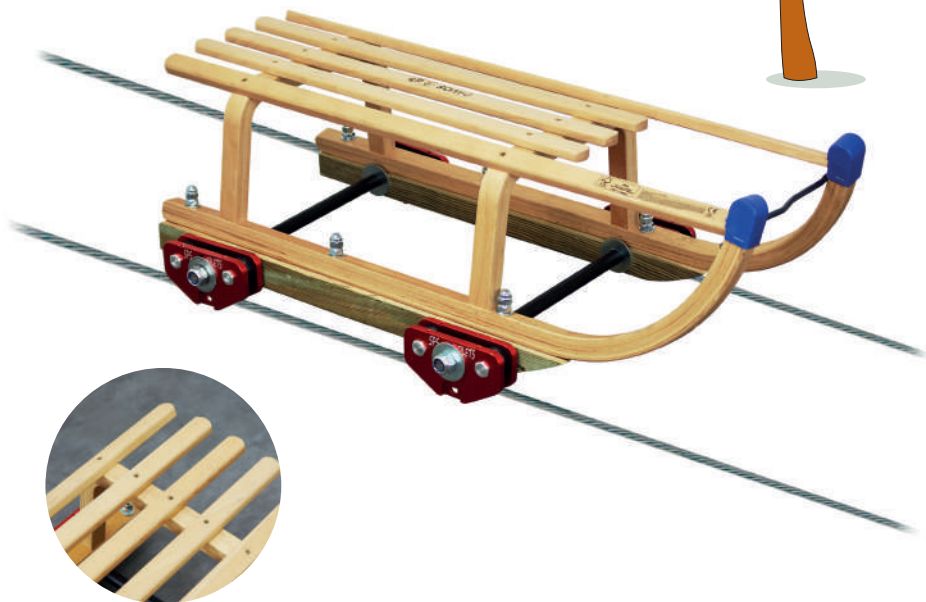

Length: 90 cm.



Fun Box

Manufacturing custom net cages with landings, labyrinth, partitions to move safely. Suitable for childrens and adults.



Level of difficulty





Available
color
Roof

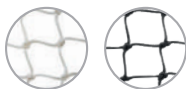

Available
color
Sides
and roof

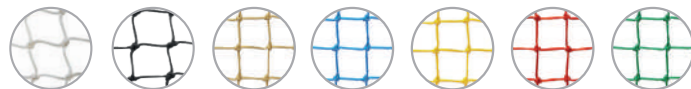

Course without harness or Sea of Nets

We craft tailor-made polyamide nets, 50 mm mesh for courses without harness.
Nets meet the requirements of EN 1263-01 Standard.



**Available
color**
Roof



**Available
color**
Sides
and roof



Door to secure your Sea of Net

Access door for Funbox or course without harness allows to secure the enter of the module Made-to-measure.

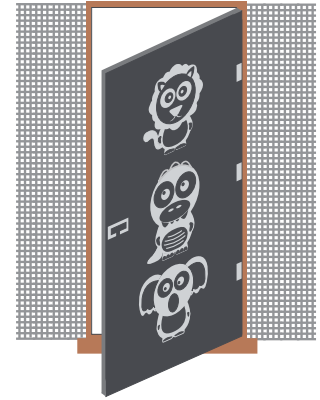

Door equipped with a bolt can have a padlock to close completely the access.

Pre-stretched halyard

Pre-stretched halyard Ø 10 mm, made of white core polyester and polypropylene cover. For net fixing and tension.

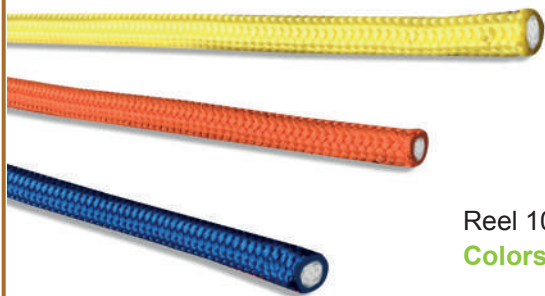

Reel 100 m.
Colors:



Photo credits - Arboricordes.

Climbing holds

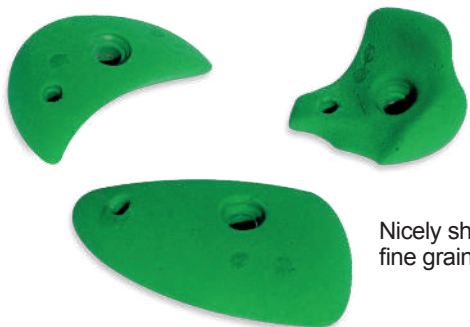

Nicely shaped,
fine grain.



Inserts

50 units Pack.
M10.

Screws

100 units Pack.
10 x 50.



Set n°1 - Climbing holds for kids

for young climbers. These holds are suitable for vertical surfaces or inclines.

Set of 22 - Color red.



Set n°2 - Climbing holds for adults

Various holds for hands and feet.

This set will enable you to start a 7 m route.

Set of 50 - Color yellow.

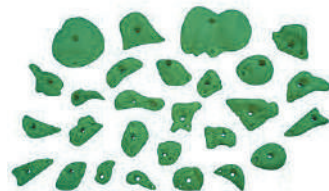

Set n°3 - Climbing holds for adults

Surprising and atypical forms. For competitors and beginners.

Set of 30 - Color green.

Climbing holds for children



Hands

Different positions.
Lot of 5 units.



Comes with assembly tools.



Animals

Butter fly, caterpillar, chrysalis, ladybirds.
Lot of 5 units.



Stones

Different shapes.
Lot of 5 units.



Colors

blue, yellow, red, green, orange.



Shapes

Plane, submarine, sailing boat, radio and telephone.
Lot of 5 units.

Available while stocks last



Numbers

Lot of 10 units.

Foam protection

Foam density 20 kg/m³ covered with a PVC tarpaulin.
Colors on request: blue, orange, red or yellow.

Other dimension on request.

Preformed

Ø inside 55 cm.
Height 90 cm.
Thickness 10 cm.



3 adjustable
straps.

Color green.



Bibs and
eyelets.

Standard

0,90 x 0,90 x thickness 0,10 m.
1,50 x 0,90 x thickness 0,10 m.



Platform protection

Equipped with aps
and eyelets. Dimension:
0,30 x 0,30 x 1,50 m.

Thickness: 10 cm.
Other length available 1 m.

Angle mattress platform protection

Foam mattress shaped for edges of platforms, thickness: 5 cm covered with a PVC tarpaulin 600 g/m².



Color green.

Dimensions

0,70 m x 0,15 m x 0,21 m.



Colors available on demand



Comfort mattress for Chimney

Foam mattress for Chimney covered with a PVC tarpaulin 600 g/m² with bibs and eyelets.

Dimensions

Ø 800 mm x 20 cm thick.

Color green.

Colors available on demand



Mattress for zipline (arrival platform)



Foam mattress density 20 kg/m³
covered with a PVC tarpaulin with
bibs and eyelets. Dimension: 0,80
x 1,60 x 0,20 m. Thickness: 20 cm.
Color green.

With or without footprints.

Jump mattress for reception

Foam mattress density 20 kg/m³ covered with a PVC tarpaulin 600 g/m² with 8 fixing eyelets.



Color green.

Crafted in 2 foldable parts with printed target.

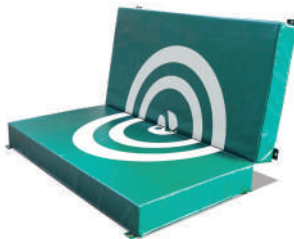

Unfolded dimensions:

2 m x 2 m x 0,20 m.

Folded dimensions:

2 m x 1 m x 0,40 m.



Colors available on demand



Level of difficulty

Foam protection for cables

Foam covered with a PVC tarpaulin.

Color green.

Dimensions:
Length 400 mm
Width 310 mm.



Velcro strap fastener



Aluminium Pulley buffer

Aluminium part for wire ropes
Ø 12 mm.



Pulley buffer
DÉVAL' CÂBLE



RODEO-STOP

Automatic fall arrest device with stainless steel shock absorber.



Compact energy absorber

Absorbs energy in the event of a fall by tearing its strap, thus limits the impact suffered by the user.

ZIPSTOP

Self-regulating magnetic braking system for zip-lines.



ZIPSTOP

Speed up to 24 km/h.

ZIPSTOP SPEED

The best break for ziplines, it breaks up to the speed of 72 km/h.



QUICK Flight

Magnetic induction braking technology.



QUICK Flight

This device offers an exhilarating experience of free fall for aerial rope courses, jump towers, fun areas etc.

QUICK Flight XL

Also available in XL size to jump from 12 m to 13 m.



TRUBLUE

The next generation of indoor and outdoor climbing wall auto belays.



TRUBLUE iQ

It covers a large range of weight: 20 to 150 kg.

TRUBLUE Speed

Its advantage is the quick retraction specific to climbing contests and trainings.



We also supply

Spirale marking

High density spiral marking for cables with 9 - 13 mm diameter.

■ red ■ blue



Elastic strap Ø 9 mm

Reel: 100 m.
Color black.



Ropes

■ In reel. Color: green, beige, textured havana, white, black.



Abseiling rope

Diameter: 4 mm.
Reel: 100 m.

Rope «INDUSTRIE»

Polyamide Ø 12 mm, breaking strength 4200 daN (kg):
50 m ■ 100 m ■ 200 m ■ 500 m.



DYNAPARK

Y shaped safety leadin a dynamic rope with sewn ends for acrobatic courses.

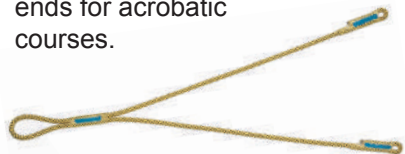

NEXUS I

Multi-purpose lanyard, Length 60 cm.



NEXUS V

V-Form lanyard, Length 80 cm.

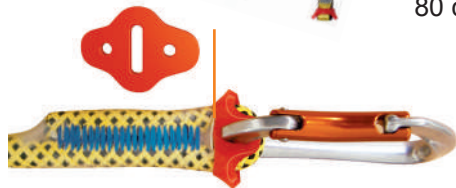

PINCH

System for securing a carabiner at the end of a rope or tape lanyard.

DYNACLIP

Lanyard in dynamic rope with sewn terminations for clipping anchors with an enhanced level of safety.



BE ONE

Carabiner to protect the rope by repeated falls.



AERO PARK

It is easy to slip into and is adjustable for children and for adults.



BAMBI

A simple and practical harness for growing climbers from age of 5 to 10 and less than 40 kg in weight.



Sangle

Flat sling Basic 18 mm. Length: 30 cm to 1,75 m.



BEAL's equipment



**Snap Hook
VERTIGO**



**Snap Hook
SPIRIT**



**Gloves for TreeTop
Adventure Parks**

For adults: size 8 and 10. **For children:** size 4 and 5. + one size for children.



PANGA helmet

For adults.
Sold per pack of 5 units Color: orange, blue, white.



**PICCHU
helmet**

For children.
Sold per unit
Color: coral or raspberry.

Pulley SBE DÉVAL' CÂBLE

For adults and children.

- Easy to use.
- Plastic wheels.
- Quiet - pulley don't wear the wire rope out.

Option

Magnetic system for easy use at the waist. facile à la ceinture.



NEWTON

Fall arrest
Harness in
big size.

(size 1
or size 2).



**Pulley
TRAC GUIDE**

A pulley for
ziplines combined
with the Vertigo
carabiner.



TANDEM SPEED

It is the fastest moving pulley. It is specifically designed for Zip games with gentle slopes.



PETZL's equipment



ASCENT harness

All-round adjustable harness, with a lumbar belt with an ergonomic and robust design that provides optimum support.



Kids
one size XXS.

Adult
XS - XL.



Carabiner KAYAK

Large carabiner, can be used as a large material holder.



Carabiner LIME-S

Classic carabiner, compact and resistant.

FLIK harness for kids

Adjustable full-body harness, equipped with two fixed attachment points. For children weighting less than 40 kg. One size.



MOON helmet

Robust and easy-to-wear helmet, developed for collective Carabiner KAYAK use. Color green /dark. green.



CLIMBING TECHNOLOGY's equipment



CIDJAY harness

Full body harness with adjustable thighs and straps.

Kids
One size.



IKKO Harness

Adjustable with straps. Available in two sizes, it is suitable for anyone looking for a harness that is simple to use and manage.



Adult
XS - 4XL.

TYRO Harness
Sitting harness seat for zip line.



AGYL Lanyard for SBE pulley

19 mm flat strap to attach a SBE pulley.
25 cm / 30 cm.



Single AKRO Lanyard (I)
with carabiner brake integrated.

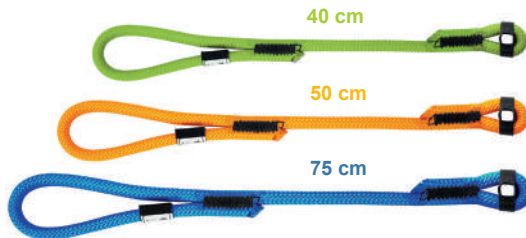

Double AKRO Lanyard (Y)

Semi-static rope: 10,5 mm, 80-80 cm, with carabiner brake integrated.

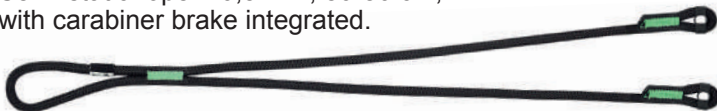

CILAO's equipment





STRATO VENT
Lightweight ventilated helmet.



PROGRIP
Torso harness shorts.



TOP
Torso harness shorts.



FALCON
Lightweight seat harness, comfortable and durable.



GRADISTEP
Bracket to help people in difficulty.



SPATHA
Multi-purpose knife.



FIXE
Pulley
flanges
for hauling.



I'DS
Self braking
descender
with anti-panic
function.



JAG SYSTEM
Haul kit enables
you to rescue
users in difficulty.



PRO TRAXION
Jamming pulley
for hauling.

**Snap Hook
OK TRIACK-LOCK**



**Snap Hook
WILLIAM TRIACK-LOCK**



AXIS 11 mm
Semi-static
rope with sew
termination
offering
excellent
abrasion
resistance.



BUCKET 15-30-45L
Freestanding canvas bag.

Evacuation equipment

Complete personal protective equipment package.



1 PRO WORK 35L
Freestanding canvas bag.



1 SPATHA



1 Snap Hook VULCAN SCREW



3 Snap Hook BE ONE



2 Sling
Flat sling basic 18 mm.
Length: 30 cm.

1 Snap Hook VERTIGO TWIST LOCK



1 I'DS



1 JAG SYSTEM



1 AXIS
11 mm
30 ml



2 Snap Hook OK TRIACK-LOCK



1 GRADISTEP

Illustration courses

The illustrations that are composing this catalogue are for sale. They enhance your whole course. It could also be customized on demand. Available on pdf, ai, png, jpeg format.



Your course explained
in a clear manner.



Full collection
of pictures on USB key.



Customized illustration
of your game.

Don't hesitate to contact us !



The Kujanak anchoring

The concept of using bolts and anchors enables an installation at a safe distance from the trunk. Thanks to this **eco-friendly method** the tree can continue to grow freely.

A bulge appears around each insert and forms a scar. This contributes to seal the wound and **reinforces the tight fit of the bolt.**

Conventional anchoring

Conventional fastening systems exert **considerable pressure on the bark**, resulting in the **death of the tree's upper layers.**

The consequences are disastrous: development of fungi, insects, bacteria...



The Kujanak platform

The Kujanak platform is environmentally friendly and 100 % recyclable. Ready-to-assemble delivery.

Douglas fir Structure

Out of sapwood: section 60 x 220, pre-drilled for bolts.

Ref KPF OCTO



Quick installation in four steps:
assembly, positioning, drilling and assembly.

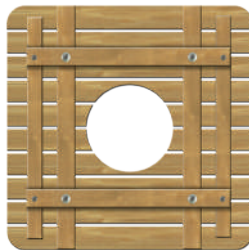
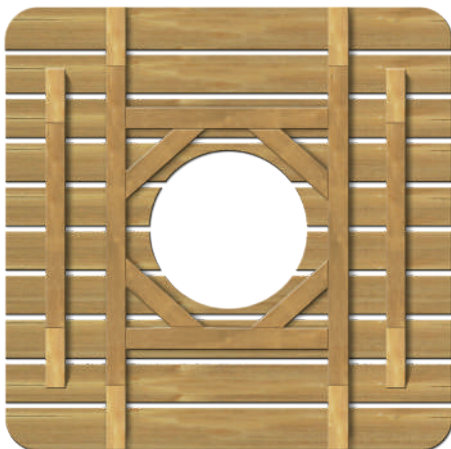

6 rafters version

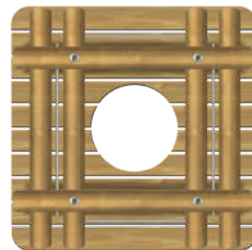

6 logs version

Anchors and bolts

In kit form *Ref KIT IG*

Set of 4 insert anchors and bolts: nuts, washers and assembly screws for wood structure.



Per unit

Ref KIG SOLO
Insert anchor and bolt per unit for cable pulling.



Drilling tools

Helicoid drill

diameter 36 x 400 for installation rings and platforms.

Ref MH36



Drilling guide

Ref GPA

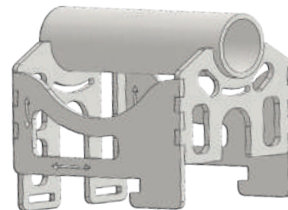

Kujanak anchoring ring

The Kujanak anchoring ring is designed to accommodate a multitude of equipment, such as lifelines, obstacles for treetop adventure parks, nets, zip lines and footbridges, providing a multi-purpose solution for your courses.

Ref KA

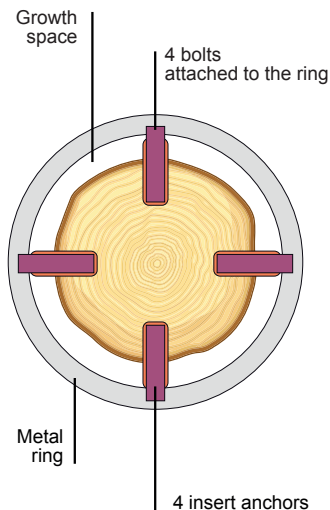

Jamb for ring

Reinforcement part for heavy loads.

Ref KJA

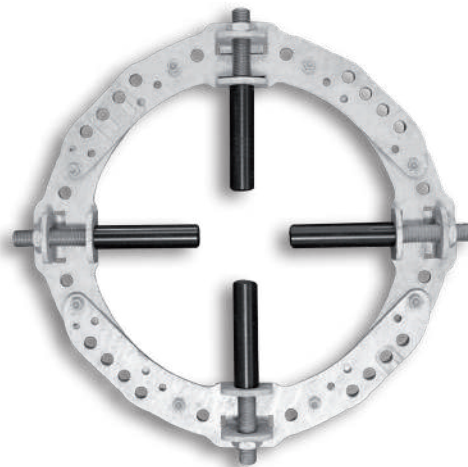

Different sizes

S	Ø 25 to 42 cm
M	Ø 36 to 57 cm
L	Ø 50 to 71 cm
XL	Ø 63 to 89 cm
XXL	Ø 98 to 145 cm

Kujanak half-ring

It is perfectly suited to the installation of your games and obstacles, sound carriers, lighting, net curtains, aviaries...



Kujanak reinforced ring

This system can support very heavy loads and be used to anchor cables, net sheets, long bridges, heavy obstacles, guy wires..

Ref KAD

Kujanak accessories

Discover Kujanak innovations that make construction and maintenance easier and faster. It means for your building crew shorter construction times. For your company: cost savings. For your customers: durable and intuitive high-performance equipment.

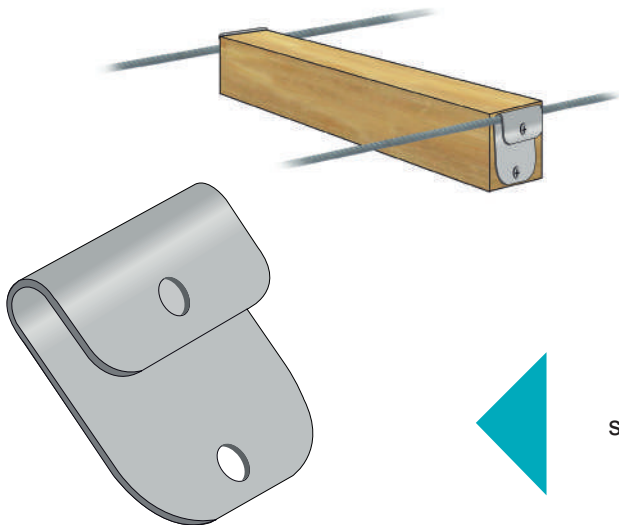

Clampo

Accessory used for fastening bridge boards on cables. For treetop adventure parks, via ferrata, aerial trails.

Ref KCLPO

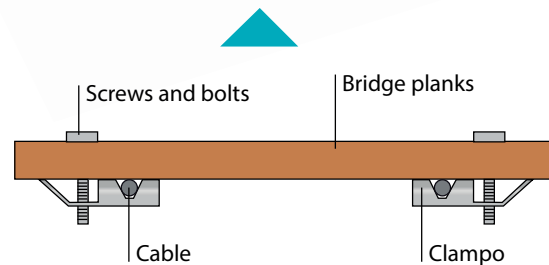
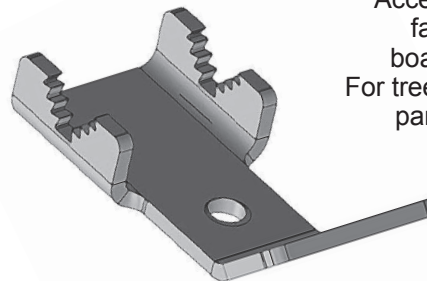

Krobois

Accessory for fastening wood beams to suspension cables using a simple screw gun. For treetop adventure parks, via ferrata, aerial trails.

Ref KKB

Kujanak accessories

Crossule

Accessory for attaching suspension ropes (e.g. swings) or footbridges to cables. For treetop adventure parks, via ferrata, aerial trails...

Ref KCS

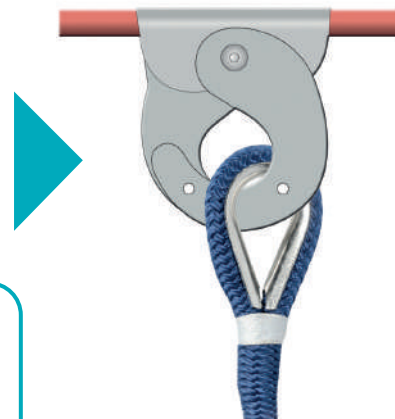

Ardicône

Designed to be positioned on the cable after crimping the barbs.

Ref KLVV

Ardicône

For vertical lifeline.

Ref KBAR

Split Ardicône

After crimping the barbs.

Ref KBARF

Kratos shock absorber

35 x 220 mm
To secure the vertical lifeline in the event of a fall.

Ref KRATOS



Engineering office

Made  by SPSfilets

In our engineering office, we design and develop new game modules to complement your courses.

We are also at your services to develop customized products according to your specific needs and infrastructure.

Our creativity is limited only by your imagination...



Tel. +33 (0)2 31 78 82 76 | contact@spsfilets.com

15 rue Ampère | 14120 Mondeville | France



www.spsfilets.com



spsfilets
Adventuring together